

Matrix KVM over IP Console (8 Port /16 Port/24 Port/32 Port) User Manual



www.kinankvm.com

@all right reserved Shenzhen Kinan Technology Co., Ltd

Print date: 2022 / 03

Version: V1.4

Table of Contents

1. Product Overview.....	3
1.1 Introduction.....	3
1.2 Features.....	3
1.3 Appearance.....	5
2. Installation and Start-up.....	8
2.1 Rack Mounting.....	8
2.2 Install KVM Components.....	9
2.3 KVM Adapter.....	10
2.4 Opening the Console.....	11
2.5 Closing the console.....	12
3. LED Operation.....	13
3.1 LED Functions.....	13
3.2 Operating the Monitor.....	15
3.3 Key Combination Function.....	16
4. User Interface Operation.....	17
4.1 User.....	18
User List.....	18
User group list.....	19
Modify password.....	21
4.2 System.....	21
Network settings.....	22
Date time.....	23
Equipment information.....	24
Encoding parameters.....	24
4.3 Security.....	25
Security Settings.....	25
Audit log.....	26
4.4 Maintain.....	26
Backup& Restore.....	27
Ping.....	27
Update.....	27
5.Remote control.....	28
5.1 Configure the target server.....	28
5.2 Remote WEB interface settings.....	30
5.3 Log in.....	33
5.4 Video Control Interface Menu.....	35
6. IP Menu Option.....	40
6.1 User management.....	41

User List.....	41
User group list.....	43
Change Password.....	45
6.2 System.....	46
Network Setting.....	47
Date /Time setting.....	48
Encoding Parameters.....	48
6.3 Safety management.....	49
Security Settings.....	49
Audit Log.....	50
6.4 System Maintenance.....	50
Backup& Restore.....	51
Ping Host.....	51
Equipment Management.....	52
Remote upgrade.....	52
7.Appendix.....	53
7.1 Specifications (17.3").....	53
7.2 Specifications (18.5").....	54
7.3 Grounding Requirements.....	55

1. Product Overview

1.1 Introduction

The IP-based KVM (IP-KVM) redirects the local keyboard, mouse and video data to a remote management console. The operator can safely manage one or many computers locally at the server site or remotely via a standard internet browser. Securely gain BIOS level access to systems for maintenance, support or failure recovery over the internet.

The IP-KVM console integrates multiple KVM switches in a 1U height console. It can control multiple computers with a set of devices including monitor, keyboard and mouse; saving cost and space by consolidating the hardware to a single device.

The IP-KVM console is fast and easy to install. Simply connect corresponding cables to the correct ports of the KVM and its module without software configuration. Connect multiple computers with compact RJ-45 connectors and CAT5e/6/7 cables, transmitting distance is up to 100M.

1.2 Features

Hardware

- 17.3" & 18.5" LCD monitor, high definition and high resolution
- Rack-mountable in a 1U EIA system rack
- Full size keyboard with integrated number pad
- Trackball eliminates the need for a separate, external mouse
- Dual power supply

Local Console

- Control up to 8 / 16 /24/ 32 computers
- Support 1 local user and 1 remote user, port share mode allows local and remote users to gain access to a server simultaneously
- Easy-to-use switching by browser-based UI interface, hotkeys and pushbuttons
- Support servers with VGA/HDMI/DVI/DP port
- Multiplatform client support (Windows, Linux, Unix, Mac, Solaris (Sun), Redhat, Ubuntu)
- Supports a graphical interface for intuitive and convenient human-computer interaction- local resolution is up to 1920 x 1080@60Hz
- Supports mouse synchronization mode-automatically synchronizes the local and remote mouse movements

- Video synchronization with local console - EDID information for local console display can be stored in the host module for video resolution optimization
- Keyboard and mouse emulation to ensure the normal booting
- Auto scan feature for monitoring user-selected computer
- Hot pluggable – add or remove computers without having to power down the switch

Remote Console

- Adaptive 10 / 100 / 1000 Mbps network
- WEB browser-based or KVM_Clients remote management
- BIOS-level access
- Video quality and video tolerance can be adjusted to optimize data transfer speed, up to 30 FPS
- Full screen or scalable video display
- Remote users and local users can control the same server synchronously
- Support AES / DES / 3DES encryption
- Support audit function-allows the administrator to audit the device through the system log and operation log
- Exit Macros support
- Configurable user and group permissions for server access and control
- Supports firmware upgrade

1.3 Appearance

Front View

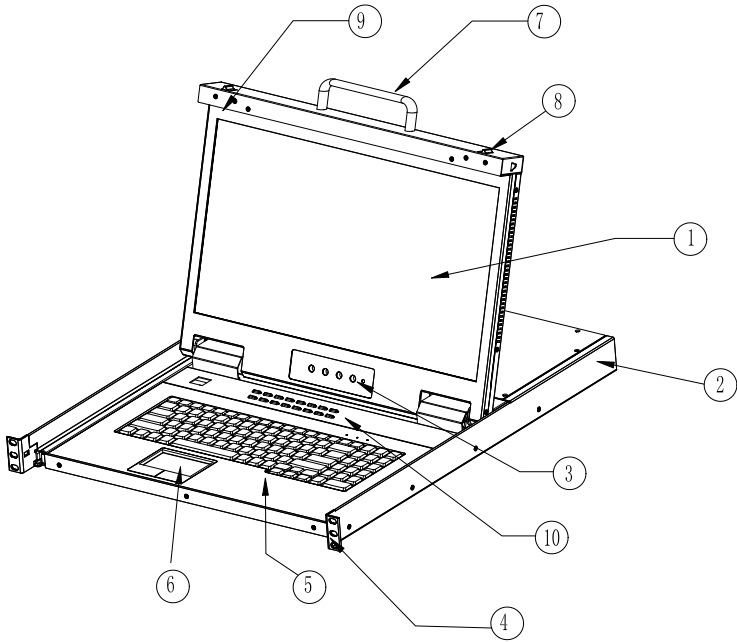

Figure 1.1 Front view

- | | |
|----------------------|------------------|
| 1. LED Module | 6. Touchpad |
| 2. Rear Bracket Slot | 7. Handle |
| 3. LED OSD Controls | 8. Release Catch |
| 4. Front Bracket | 9. Display panel |
| 5. Keyboard | 10. Switch LED |

Structure and Size

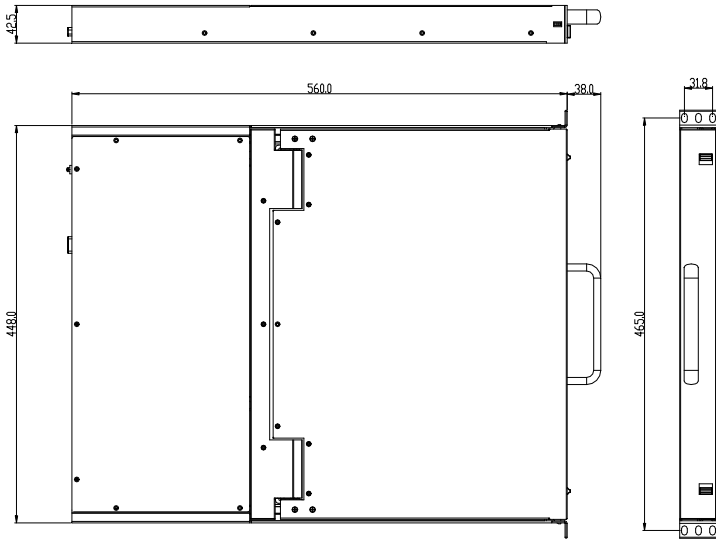

Figure 1.2 dimensions

Rear View

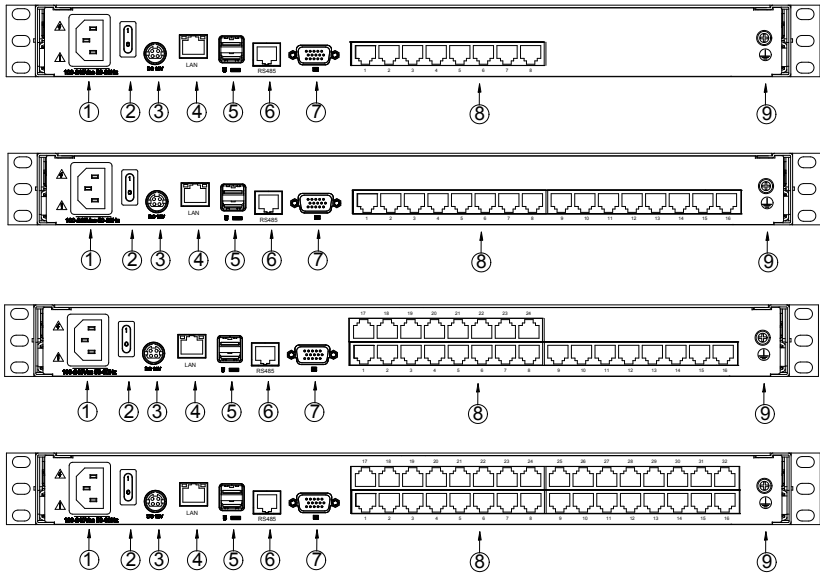

Figure 1.3 Rear view

1. Power Input (AC)
2. Power Switch
3. Power Input (DC)
4. LAN Port
5. USB Port
6. RS485 Port
7. Monitor Port
8. PC Connecting Port
9. Ground Screw

2. Installation and Start-up

2.1 Rack Mounting

A standard rack mounting kit is provided to mount the switch in a depth of 686-770 mm in a standard 19" rack. For other mounting distances, the rear brackets need to be customized accordingly. With one person hold the switch in place, the other person slides the L bracket into the switch's side mounting brackets from the front to the back, then screws the brackets to the rack (see below installation drawing).

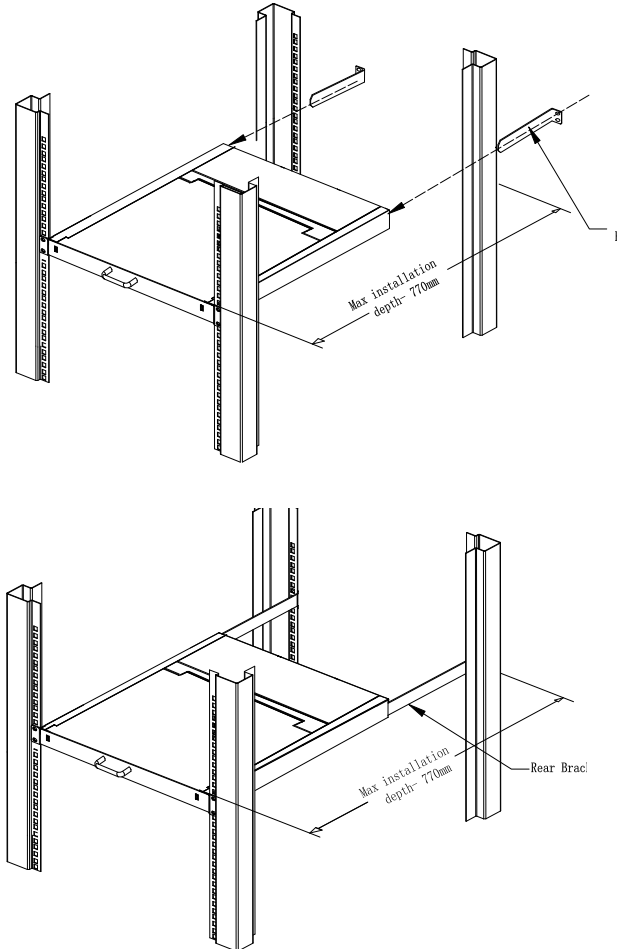

Figure 2.1 Rack Installation Diagram

2.2 Install KVM Components

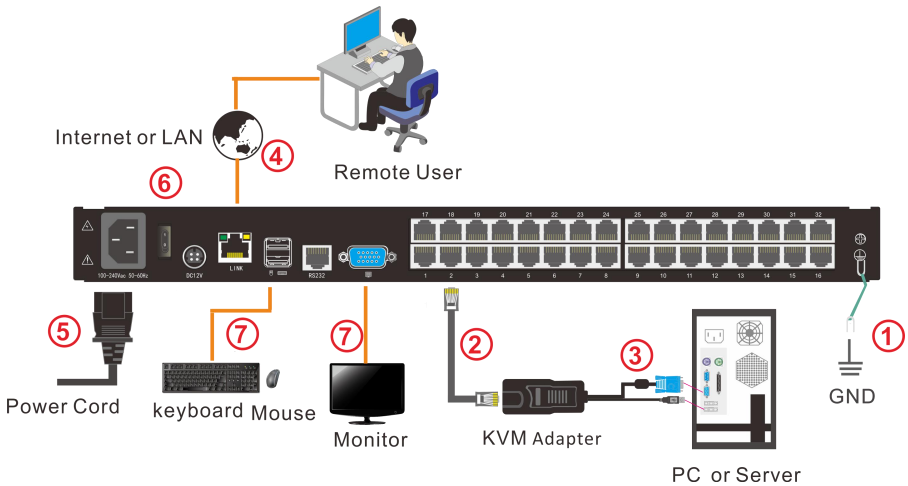
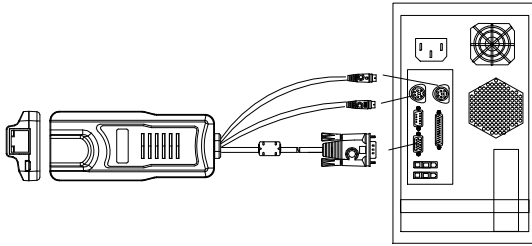

Figure 2.2 Installation diagram

Installation Steps:

1. Make sure the KVM console has been connected to the ground.
2. Connect the KVM adapter to the PC or Server.
3. Connect the KVM adapter to the KVM port with a CAT5 cable.
4. You can remote control the KVM switch via IP.
5. Using power adapter to connect the KVM into 220V AC power supply.
6. Power on the switch
7. Connect the external keyboard, mouse and monitor (optional)

2.3 KVM Adapter
PS/2 Adapter



Model No.	Keyboard/Mouse	PC	Explanation
KCM-1100P	PS/2	VGA	Connect to PS2/VGA server

USB Adapter

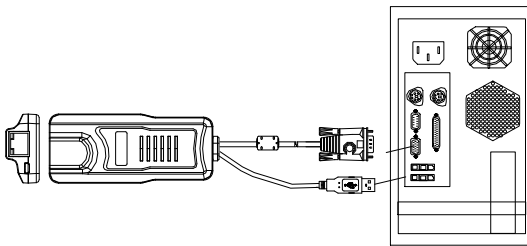

Model No.	Keyboard/Mouse	PC	Explanation
KCM-1200U	USB	VGA	Connect to USB/VGA server
KCM-3200H	USB	HDMI	Connect to USB/HDMI server
KCM-2200D	USB	DVI	Connect to USB/DVI server
KCM-4200P	USB	DP	Connect to USB/DP server

Table1: LED Indicator of the KVM Adapter

Components	Function	
Green	Online	Indicates that the corresponding host has been connected to the KVM switch and Power On.
Orange	Selected	Indicates that the corresponding host is in use.

2.4 Opening the Console

1. Release the release catch;

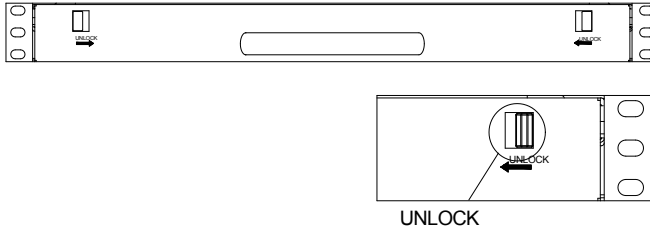

Figure 2.3 Unlocking

Note: The release lock can only do horizontal locking, it doesn't bear any load.

2. Pull the KVM console all the way out until it clicks into place;
3. Rotate the LCD module all the way back to expose the LCD screen; the LCD module can be rotated up to 108°.

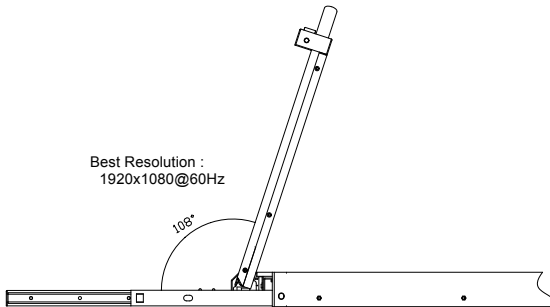
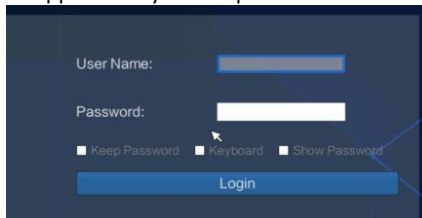

Figure 2.4 Open angle of the console

4. The KVM makes two “beep” sounds after power on, the orange light keeps flashing and an UI window appears for you to input user name and password.



User Name:	admin
Password:	admin

5. LCD panel is powered on when the power LED is green.
6. Power on the computer or server after power on the KVM.

2.5 Closing the console

- Close the LCD display panel and the power automatically shut down.
- Push the KVM into the cabinet: When pushing forward, the rail will be unlocked automatically; push forward until the KVM is fully pushed into the cabinet, the KVM will be automatically locked.

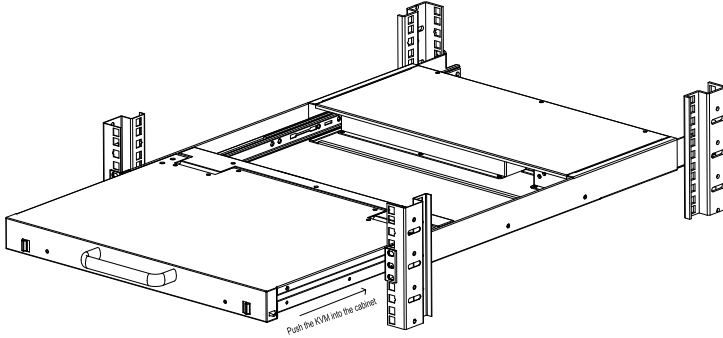

Diagram 2-5 unlocking the console

3. LED Operation

3.1 LED Functions

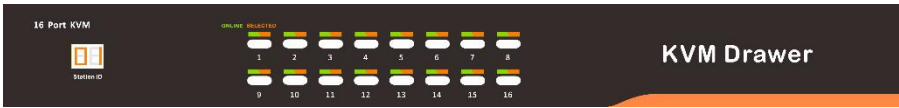





Figure 3.1 LED front views

No.	Components	Function
1	1-16	Switching freely from port 1 to port 16
	Reset	Press 【1】 and 【2】 at the same time for three seconds resets the keyboard and mouse
	Scan	Press 【7】 and 【8】 at the same time for three seconds enters the auto scan mode.
	Brightness 	Press 【3】 for three seconds enters brightness adjusting mode. 33 are flashing on the LED tube. Then press 【5】 , 【6】 to adjust. Press 【3】 exits or waits for five seconds and it will auto-exit.
	Definition 	Press 【4】 for three seconds enters definition adjusting mode. 44 are flashing on the LED tube. Then press 【5】 , 【6】 to adjust. Press 【4】 exits or waits for five seconds and it will auto-exit
	Initialize 	Press 【6】 for three seconds will initialize the brightness and definition of each port.
2	Port Selection Buttons & LEDs	Indicator LEDs are built into the switches, the online LED light is on the left and the selected LED light is on the right. <ol style="list-style-type: none"> An online LED light (green) indicates that the KVM has connected to its corresponding computer and power on. A selected LED light (orange) indicates that the computer attached to its corresponding port is up and running.
3	Station ID	Display the current port

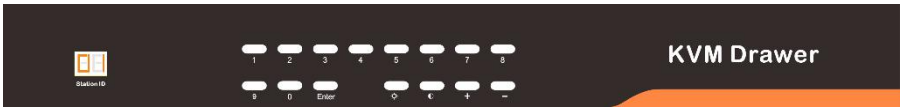









Figure 3.2 32 Port LED front views

No.	Components	Function
1	0~9 +Enter	Switching from port 1 to port 32 Port 8 : If you want to switch to Port 8, press【8】, and the LED light displays  , then press “Enter”, you will come to Port 8. Port 32: If you want to switch to Port 32, press 【3】 and 【2】 , the LED light displays  , and then press “Enter”, you will come to Port 32.
2	 (+, -)	Adjust Brightness Press  , the LED light blinking with  , and then press “+” and “-” to adjust the brightness.
3	 (+, -)	Adjust Definition Press  , the LED light blinking with  , and then press “+” and “-” to adjust the definition.
4	Station ID	Display the current port

3.2 Operating the Monitor



Figure 3.3 Monitor adjust menu buttons

The LED OSD allows you to set up and configure the LED display.

Buttons	Functions
MENU SELECT	Brings up the main menu.
EXIT/AUTO	Exits the current menu and returns to the previous menu or exits the LED OSD. Press AUTO for automatic configuration.
SL-/SL+	Moves the menu to make corresponding adjustment.
LED state	Green: Running Red: Power off or access nonstandard VESA signal Flashing green: Energy saving mode or no signal

Press AUTO if the screen migrates after power on or under other circumstances, then the screen auto-configures to its best display state.

Note:

- *It may not be adjusted to its best state if part of the display mode is not standard VESA mode. If so, return back to OSD menu to RESET, then it will revert back to normal.
It is recommended to set up the display mode at 1920×1080, refresh rate at 60Hz.*

3.3 Key Combination Function

If you want to set other hotkeys to pop up the UI interface or key combination switch, set up the via the local console, **【System Settings】 > 【Device info】**

Pop up the UI interface	Double click 【L_Ctrl】 Double click 【L_Alt】 Double click 【Scroll Lock】 Double click 【Caps Lock】
Hot key	【L_Alt】 + 【L_Ctrl】 【L_Win】 + 【L_Ctrl】 【L_Alt】 + 【L_Win】

Hotkey commands are as follows:

Hot key + the corresponding function key

Function	Operating	Function description
Port switch	+Number	Skip ports from 1~16
	+ 【↑】 / 【→】	Skip to previous port
	+ 【↓】 / 【←】	Skip to next port
Brightness	+ 【+】	+
	+ 【-】	-
definition	+ 【>】	-
	+ 【<】	-
Reset Video	+ 【R】	Reset the video
Lock KVM	+ 【L】	Lock KVM and a user login window appears

4. User Interface Operation

login UI control menu

User Name: admin

Password: admin

After logging in the device, you can see the connection status of the device port.

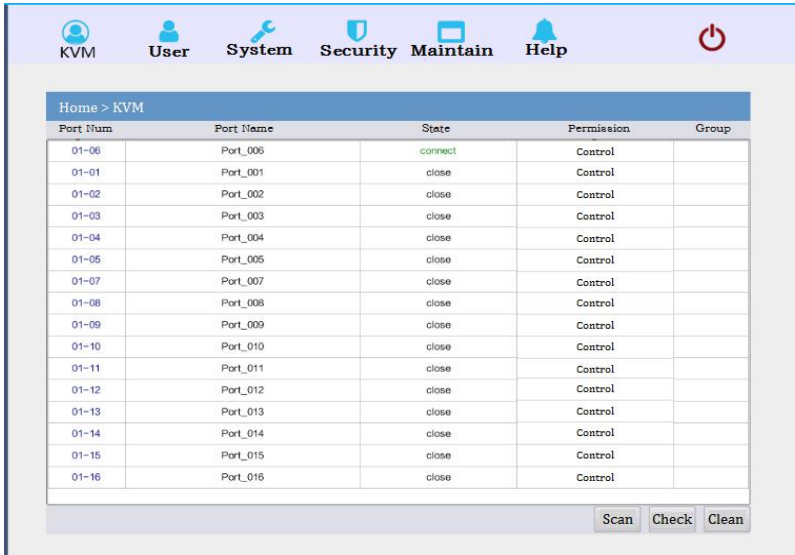

The screenshot shows the KVM user interface. At the top, there is a navigation bar with icons and labels for KVM, User, System, Security, Maintain, Help, and a power button. Below this is a table titled "Home > KVM" with the following columns: Port Num, Port Name, State, Permission, and Group. The table lists 16 ports, with Port_006 in a "connect" state and all other ports in a "close" state. At the bottom right of the table, there are three buttons: Scan, Check, and Clean.

Port Num	Port Name	State	Permission	Group
01-06	Port_006	connect	Control	
01-01	Port_001	close	Control	
01-02	Port_002	close	Control	
01-03	Port_003	close	Control	
01-04	Port_004	close	Control	
01-05	Port_005	close	Control	
01-07	Port_007	close	Control	
01-08	Port_008	close	Control	
01-09	Port_009	close	Control	
01-10	Port_010	close	Control	
01-11	Port_011	close	Control	
01-12	Port_012	close	Control	
01-13	Port_013	close	Control	
01-14	Port_014	close	Control	
01-15	Port_015	close	Control	
01-16	Port_016	close	Control	

In the port list,

1. Click the "Connect" to enter the host screen;
2. In the host screen, press the [L_Ctrl] key on the keyboard twice.
3. Return to the UI interface.

4.1 User

User management mainly set up for adding, deleting and modifying user& user group, user password modification, user group permissions and so on. If the user does not have user management authority, the user cannot access to user management interface. The user in this section is who have the user management authority.

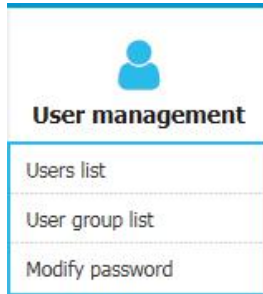

User List



User list interface: list all registered users, you can see more by page turning

- User name or full user name search
 Input user name, it shows related users which make it convenient when you have a large number of users

■ Add user

Click **[add]** button, the window below appears:

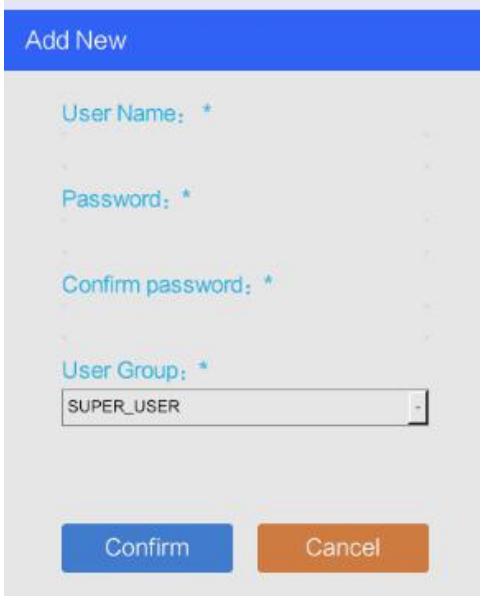

In this window, "*" is required content

- 1) User name: user name can only be low case letter, number and “_”
- 2) Enter password: without strong password protection, the password can only compose of 1-16 letters, numbers or special characters (-@. \$! _); with strong password protection, the password should be filled in according to the rules of strong password protection. More details please check “security management—>security setting—>strong password”
- 3) User group: Select the corresponding user group

User group list

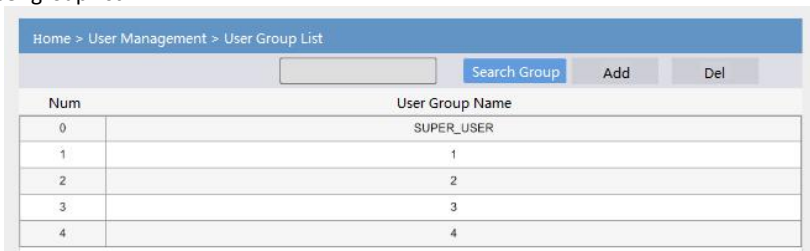

Num	User Group Name
0	SUPER_USER
1	1
2	2
3	3
4	4

User group list interface: List all registered users, you can see more by page turning

- User group name search
Input user group name, it shows related user groups which make it convenient when you have a large number of users
- Add user group
Click **[add]** button, the window below appears

Add Group

UserGroup Name: *

permission

KVM user control system Settings safety control Maintenance

port authority

Numuber	Port Name	port access	virtual media	Shortcut
1	Port_001	View	Refuse	All ports for v
2	Port_002	View	Refuse	
3	Port_003	View	Refuse	
4	Port_004	View	Refuse	
5	Port_005	View	Refuse	
6	Port_006	View	Refuse	
7	Port_007	View	Refuse	
8	Port_008	View	Refuse	

< >

Confirm Cancel

1) User group name: it contains only low case letter, number and “_”

2) Authority: mainly refers to management authority and operation authority, click show more, authority menu appears (shown in picture above), click show less, authority menu disappears

- ✧ Port Access: Authority to access KVM, and control target server
- ✧ User Management: user management authority
- ✧ Device Setting: KVM device management authority
- ✧ Security Management: security management authority
- ✧ System Maintenance: system maintenance authority

3) Port authority: set up access and operating authority for each port

Modify password

Change the User login password.

Home > User Management > Modify Password

Original Password : *

New Password : *

Confirm password : *

Confirm

In this window, "*" is required content

- 1) User name: it contains only low case letter, number and “_”
- 2) Enter password: without strong password protection, the password can only compose of 1-16 letters, numbers or special characters (-@. \$! _); with strong password protection, the password should be filled in according to the rules of strong password protection. More details please check “security management—>security setting—>strong password”
- 3) User group: Select the corresponding user group

4.2 System

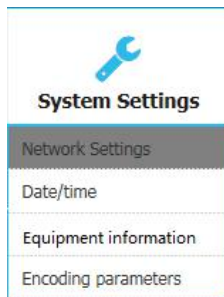

Network settings

Network Settings System Settings > Network Settings

Network Settings

IP Address :

Subnet Mask :

Gateway :

MAC :

DCSG Settings

DCSG IP

DCSG Port

IPv4 address setting:

- ✧ IP address: preset IP address
- ✧ Subnet mask: Generally, it should be consistent with other devices in the network.
- ✧ Default gateway: Generally, it should be consistent with other devices in the network.
- ✧ MAC address: physical address
- ✧ DCSG IP: the IP address should be the same with the Authentication Server IP address
- ✧ DCSG Port: The Port should be the same with the Authentication Server Port.

Date time

Date Settings

System Settings > Date Settings

Date Settings

User setting time

Date Settings:

1970-01-14

Time Setting:

13:48:29

Synchronize with the NTP server :

Time server:

202.120.2.101

Select time zone:

West 12 (central Pacific)

confirm cancel

System time setting:

- Customized time: manual setting
- Synchronize with the NTP server: the system automatically updates the time according to the time

Equipment information

Encoding parameters

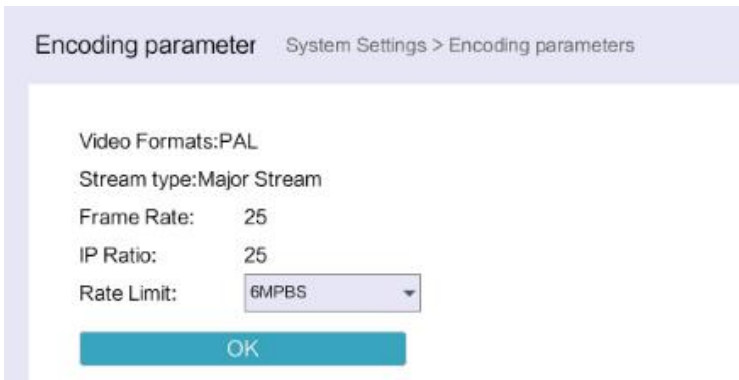

4.3 Security

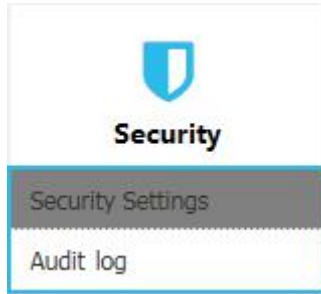

Security Settings

Home > safety management > Security Settings

<p>logon restric</p> <p><input type="checkbox"/> Restrict single sign-on.</p> <p><input type="checkbox"/> password expiration <input type="text" value="50"/> Day</p> <p><input type="checkbox"/> Cancellation user <input type="text" value="36"/> (1-365minutes)</p>	<p>Login lock</p> <p><input type="radio"/> Disable lock</p> <p><input type="radio"/> Account lock try <input type="text" value="60"/></p> <p><input checked="" type="radio"/> Timed lock try <input type="text" value="60"/> Locking <input type="text" value="2"/> (1-1440minutes)</p>
<p>Strong</p> <p><input type="checkbox"/> Enable password</p> <p><input type="checkbox"/> Contain lowercase <input type="checkbox"/> Contain uppercase</p> <p><input type="checkbox"/> Contain Number</p> <p>password depth <input type="text" value="3"/></p> <p>Min/max length <input type="text" value="1"/> - <input type="text" value="16"/></p>	<p>Encryption s</p> <p>Local info encryption mode <input type="text" value="No ENCRYPTION"/></p> <p>Local device reset mode <input type="text" value="Enable Local Factor"/></p> <p><input type="checkbox"/> Encryption mode is applied to KVM and virtual</p>

- Login restriction: user name login restriction
 - ✧ Single sign on restriction: if one user name is logged in, it can no longer log in with this user name, if it is selected, you can log in with the user name
 - ✧ Enable passwords expiration: current password use days ranges from 1-365 days, if it is selected, the default is 50 days
 - ✧ Free user logs off: If user do not have operations after logging in a set time, the user will be logged off automatically
- Login lock
 - ✧ Disable Lock: when it is selected, login lock will be canceled
 - ✧ Account lock: set trying number of times for login attempts failed
 - ✧ Timed lock: set the account lock time when account login failed attempts are over the setting number of times
- Strong password
 - ✧ Enable strong password: when it is selected, the original password will be forced to be changed

- ✧ Password history depth: new password cannot be the same as the latest 3 default passwords, this number can be changed, it ranges from 1-10
- ✧ Strong password length: From 1-bit to16 bits.

■ Encryption mode

DES
 AES128
 AES256

- ✧ Local information encryption mode: three encryption schemes and one un-encryption scheme
- ✧ Encryption mode is applied to KVM and virtual media: applied when it is selected

Audit log

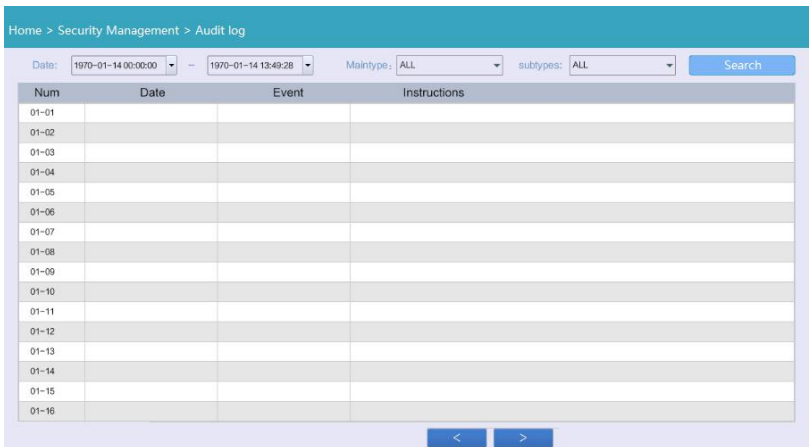

4.4 Maintain

Provide system maintenance tools such as test tools, data backup and restart

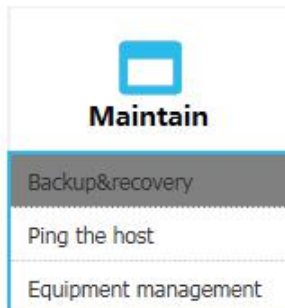

Backup& Restore

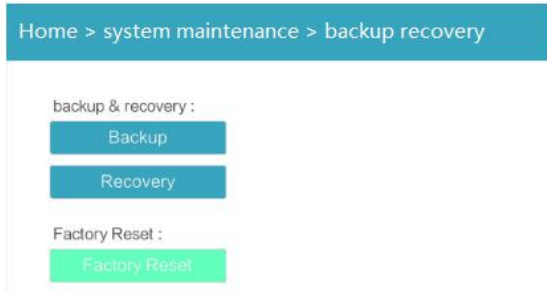

Backup: backup current system settings

Restore: restore the last backup of system

Factory reset: Restore to factory state (KVM must be restarted to take effect)

Ping

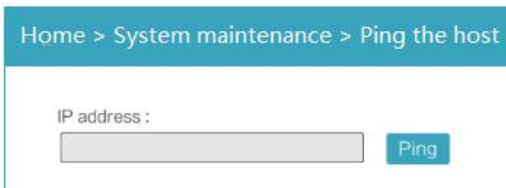

Update



5.Remote control

5.1 Configure the target server

The KVM target server is the server that connected to the IP KVM Switch. Before install and use the IP KVM Switch, we need to configure the target server first. Please refer to below configuration instructions:

- ◆ The IP KVM switch supports below two mouse mode:
 - ◇ Absolute mouse mode
 - ◇ Relative mouse
 - ◇ Intelligent mouse mode

Mouse configuration is different for different operating systems; please refer to below detail instructions for mouse configuration.

- ◆ **Mouse and display configuration on Windows server 2003 and above version, Windows XP and above version**

Operating systems: Windows server 2003, Windows server 2005, Windows server 2008, Windows server 2012; Windows XP, Windows7, Windows8, Windows10

- ◇ **Set Mouse Precision**

Start—>Control Panel—> [Hardware]—>Mouse

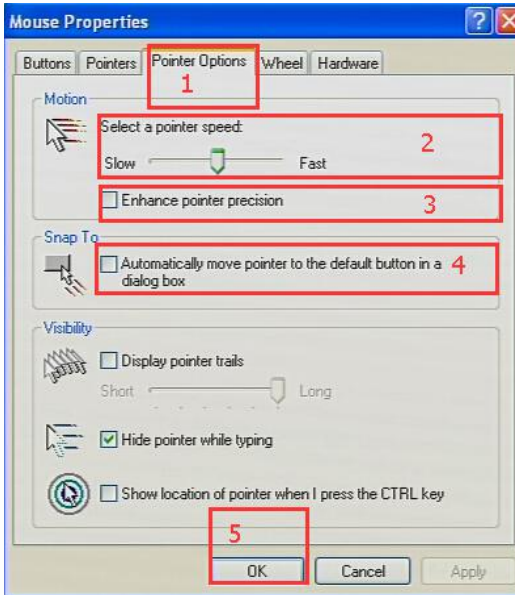

Please follow the steps above to finish the setting.

✧ **Set up the display of the target server under Windows XP, Windows 2003, Windows2008**

Start—>Control Panel—> [Hardware]—>Display

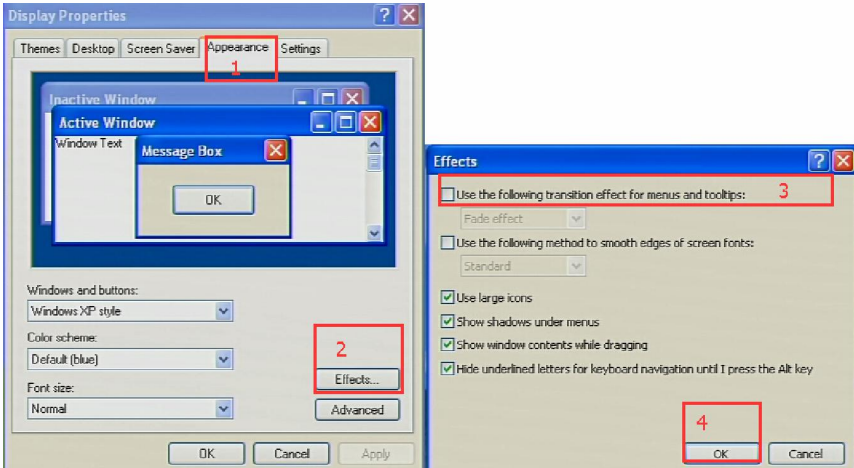

Please follow the steps above to finish the setting.

◆ **Configure the mouse under Linux (ubuntu 10)**

Input “xset m 1 1” in the Linux command line terminal and press Enter to finish the mouse setting, as shown below.

```
File Edit View Search Terminal Help
kinan@ubuntu:~$ xset m 1 1
kinan@ubuntu:~$
```

5.2 Remote WEB interface settings

Install and open IE browser, click top-right settings→ **Internet Options**

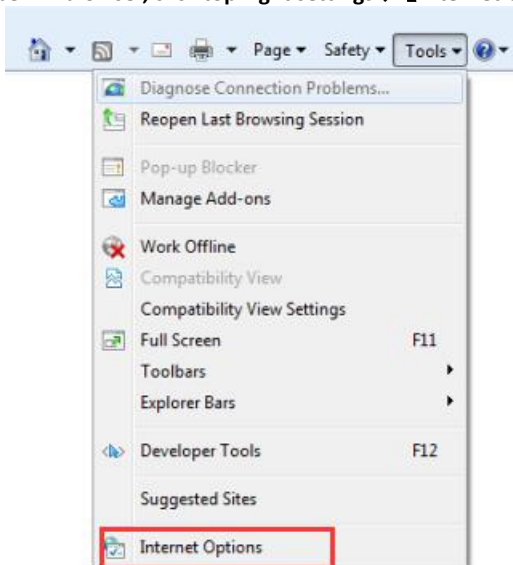

Click **Security → **Custom Level****

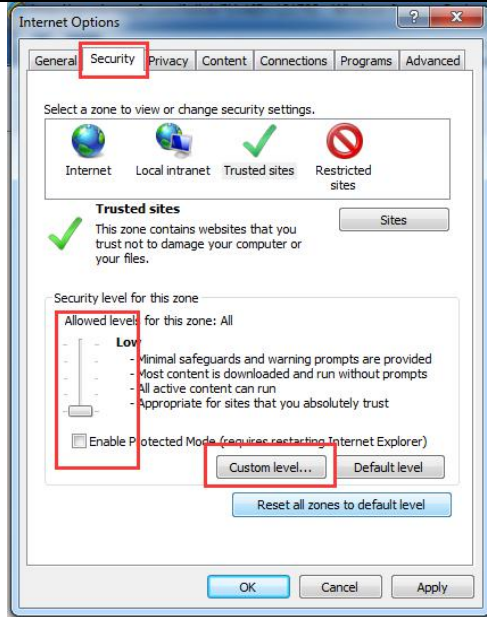

【ActiveX controls and plugins】

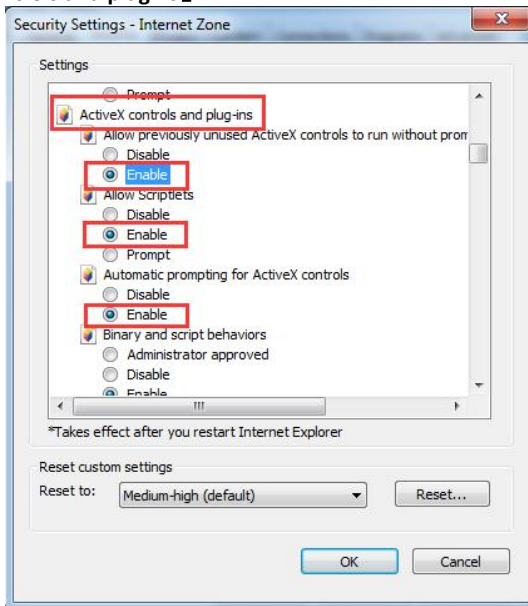

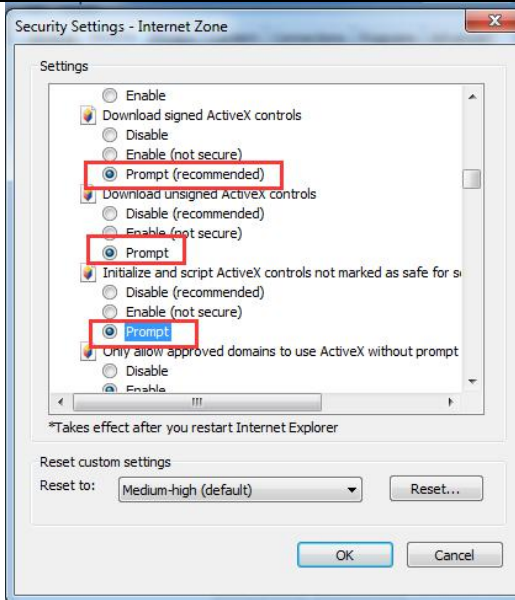

Click **Advanced** , find **Allow software to run or install even if the signature is invalid** and select it.

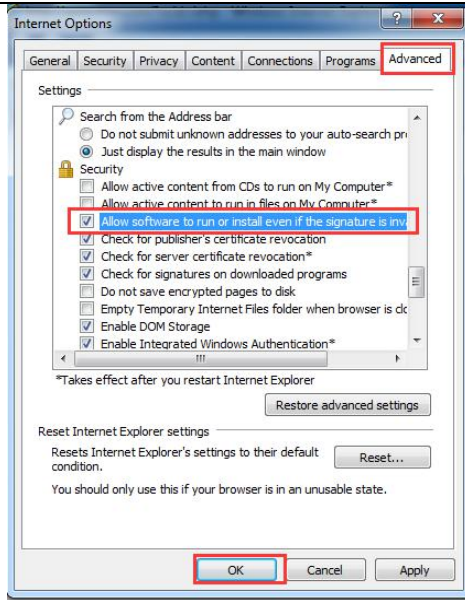

5.3 Log in

Default Items	Default Value
User name	admin
Password	admin
IP address	192.168.1.167
Notice: For security, please change the password after the first login Differentiating between capital and lowercase letters.	

After connecting the device, open the Internet explorer web browser:
[http:// 192.168.1.167](http://192.168.1.167)

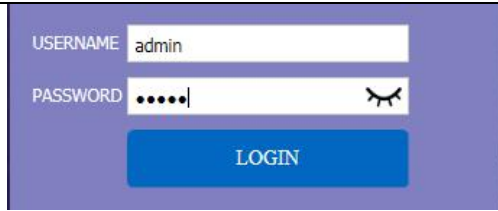

User Name: admin
Password: admin

After logging in for the first time, a prompt for loading the ActiveX will appear below the browser. Clicking “Allow” will bring up the Download Video Plugin dialog box. Click “OK” to use the video plugin.

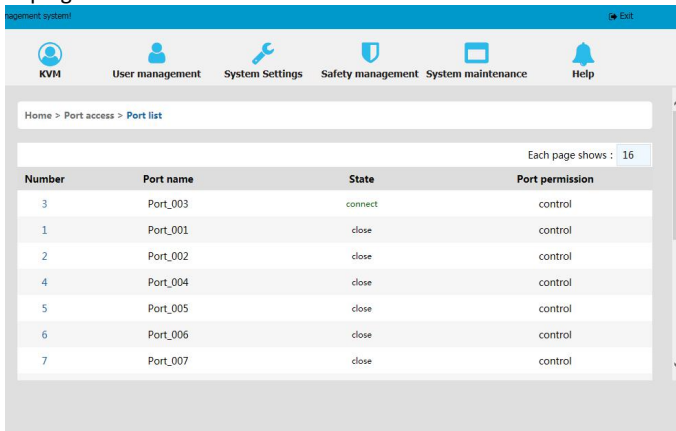

Access status of the KVM ports, three connection status:

1.busy, 2. Connect , 3. close

- ✧ “Connect” shows the target KVM is connected to the KVM port; users can access to the target anytime.
- ✧ “close” shows that the KVM is not connected to the KVM adapter or the target server, or the target server is not boot up.
- ✧ “busy” shows that port is access by local or remote users.

Edit Port Name:

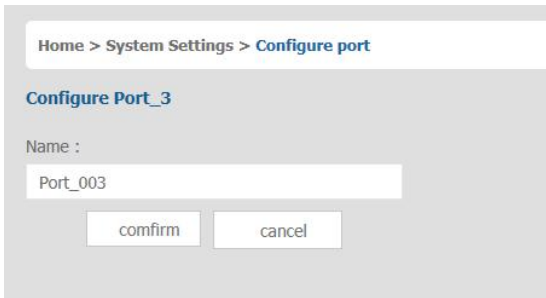
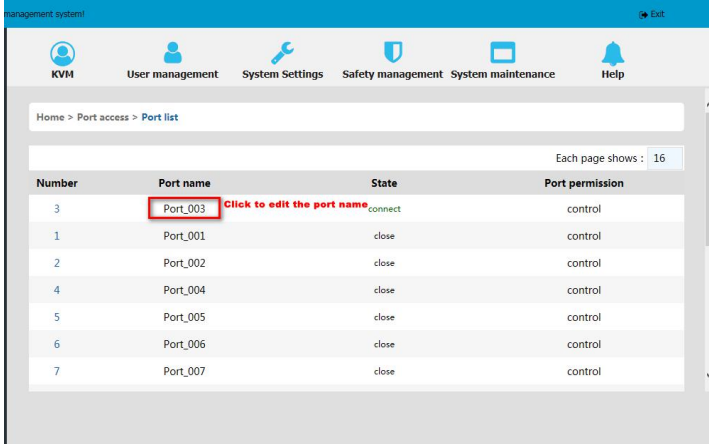

5.4 Video Control Interface Menu



【Hide or Show Toolbar】

【Setting Option】

【Send Ctrl+Alt+Del】

【Mouse Synchronization】

【Single Mouse】

【Adaptive Window】

【Source Video params】

【Full Screen】

1) Hide or Show Toolbar

When the video window starts, the toolbar is always displayed by default.

Click the icon, the toolbar will automatically hide. When the mouse moves out (into) from the toolbar, it hides shows).

2) Setting Options

2.1 Keyboard & Mouse Options

When user has the authority (chart 5-1.1)

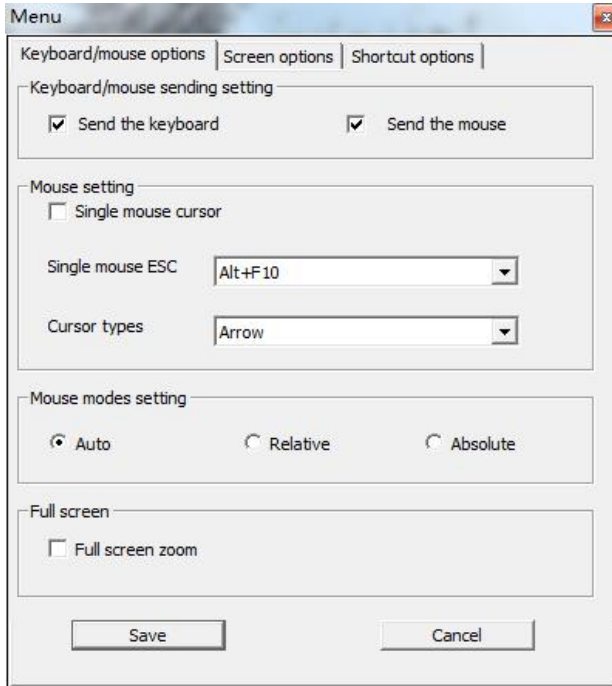

Chart 5-1.1

- Keyboard/mouse sending setting
 - Send the keyboard: keyboard data can be sent to the target server through the video window so that it can control the target server's keyboard.
 - Send the mouse: mouse data can be sent to the target server through the video window so that it can control the target server's mouse.
- Mouse Setting
 - Single mouse cursor: when single mouse chosen, target server's mouse will show and remote user's mouse will hide
 - Single mouse ESC: press the keyboard "Alt + F10" exit the single mouse mode.
 - Cursor types: it can set remote user's mouse cursor type in double mouse mode
- Mouse Mode Setting:

- Relative mode: Relative mode is compatible with almost all the operating systems; the factory default mode is relative mode.
 - Absolute mode: The absolute mode is not compatible with LINUX operating system.
- Full Screen Setting
- Full Screen Zoom: If the “Full Screen Zoom” is disabled, the video will be displayed in the remote full screen; If the “Full Screen Zoom” is enabled and the target server’s resolution is different from the remote user computer’s resolution (the resolution of the general target server is less than the resolution of the remote user computer), the video plug-in will display the screen in the middle of the screen according to the resolution of the target server.

When users only have authority to view, remote users can only view the video window and cannot control it, as shown in Chart 5-1.2.

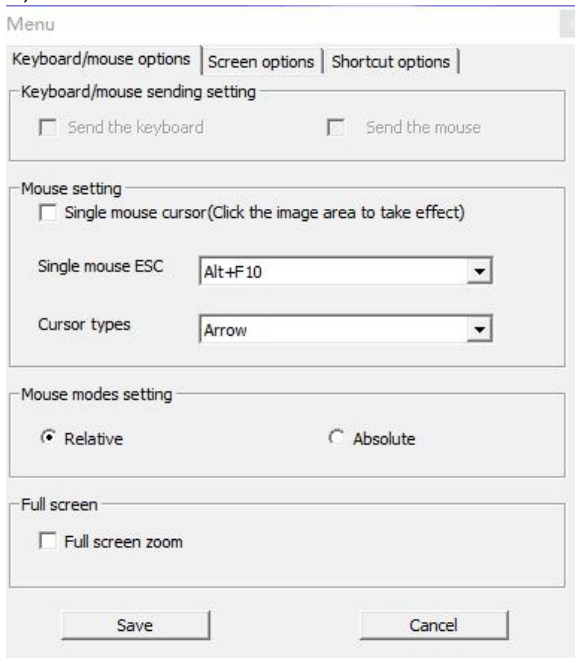

Chart 5-1.2

2.2 Display option

Display option dialog shows screen parameters and screen information, as shown in 5-1.3

- Frame Parameter
 - Automatic calibration: The video window will automatically adjust the screen parameters of the target server to the default best effect.
 - Contrast, brightness, hue and saturation: if “automatic calibration” is disabled, users can customize screen parameters of target server.
- Frame information
 - Resolution: it shows the resolution of the target server. When the target server’s platform is win10, it shows the resolution of video
 - IP address: IP-KVM console IP address
 - Refresh Rate: video refresh rate
 - Port number: video port number
 - Manual calibration resolution: when the resolution of the target server is not consistent with the resolution of the video window, it can manually calibrate the resolution after calibration
 - Target server resolution: resolution selection of manual calibration
 - Target server’s picture zooming: Under the win10 system, if the resolution is not the best resolution, the win10 system will zoom the video screen, and the video window cannot automatically identify whether the video source picture is zooming or not, then the user need to select the option by its own.

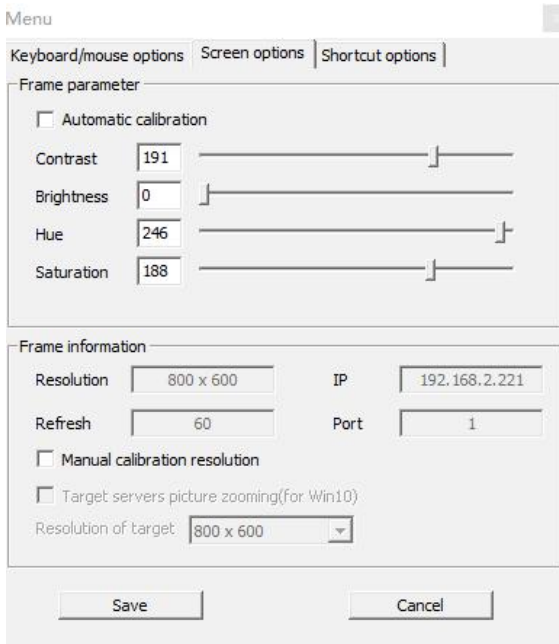

Chart 5-1.3

2.3 Keyboard Shortcuts

Support 11 keyboard shortcuts, each with a maximum of 6 keys.

It can save shortcut keys and can be directly used when logging in next time. Shown as chart 5-1.4

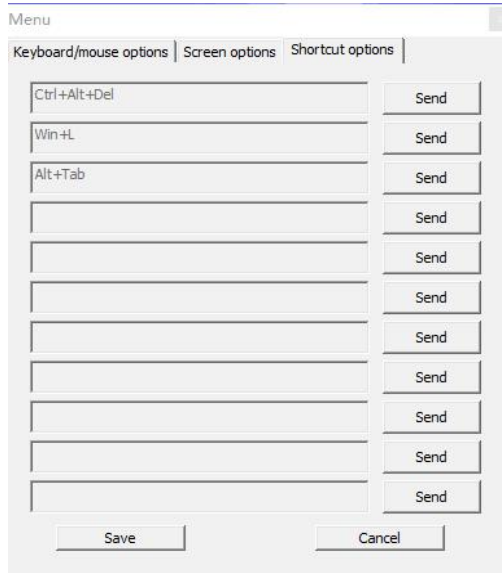

Chart 5-1.4

Click blank input box, virtual keyboards appears, and then key clicked on the virtual keyboard will be displayed in the input box.



3) **Send** -----send Ctrl+Alt+Del

Keyboard Macro: click this button, the target server will receive shortcut key.

2 Send Ctrl+Alt+Del

Bring up the task manager of target server (Windows operating system)

4) **Mouse Synchronization**

In double mouse mode, click this button to automatically collate the current mouse, and synchronize the external mouse and internal mouse to the origin of the left corner of the video window.

5) **Single mouse**

In the video window, it will hide the remote user's mouse, and only show the target server's mouse.



6) Source video params

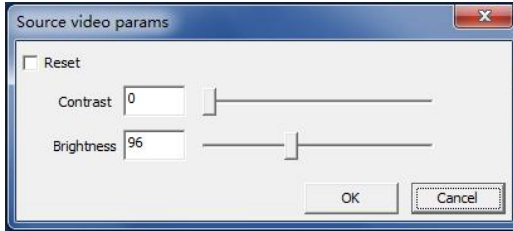

7) Optimum size

The initial size of the video window is 1024x768, when click this button, the video window will adjust the size of the window according to the resolution of the target server.



8) Full Screen

The video window enter full screen mode

6. IP Menu Option

6.1 User management

User management mainly set up for adding, deleting and modifying user& user group, user name password modification, user group permissions and so on. If the user does not have user management authority, the user cannot access to user management interface. The user in this section is who have the user management authority.

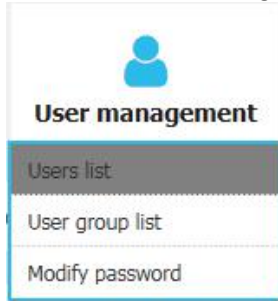

User List

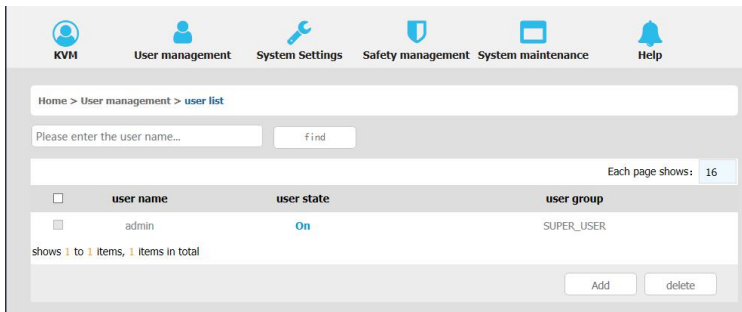

User list interface: list all registered users, you can see more by page turning

- User name or full user name search
 Input user name, it shows related users which make it convenient when you have a large number of users

- Add User
 Click **add** button, the window below appears:

Home > User management > Add user

Add user

username *
Please enter the user name

Set password *
Please enter password

Confirm password: *
Please confirm the password

User groups *
SUPER_USER

confirm cancel

In this window, "*" is required content

- 1) User name: user name contains only low case letter, number and “_”
- 2) Enter password: without strong password protection, the password can only compose of 1-16 letters, numbers or special characters (-@. \$! _); with strong password protection, the password should be filled in according to the rules of strong password protection. More details please check “security management— > security setting— > strong password”
- 3) User group: Select the corresponding user group

■ Delete User

Select the user you want to delete, click **【delete】**,

Home > User management > user list

Please enter the user name... find

Each page shows: 16

<input type="checkbox"/>	user name	user state	user group
<input type="checkbox"/>	admin	On	SUPER_USER
<input checked="" type="checkbox"/>	user1	Off	SUPER_USER

shows 1 to 2 items, 2 items in total

Add delete

Note: admin cannot be deleted, other users can be deleted, even if they are online.

■ Edit user

Click **A1** , edit user window pop up

Home > User management > [user list](#)

Please enter the user name...

Each page shows: 16

<input type="checkbox"/>	user name	user state	user group
<input type="checkbox"/>	admin	On Click to edit the user	SUPER_USER
<input type="checkbox"/>	user1	Off	SUPER_USER

shows 1 to 2 items, 2 items in total

Home > User management > [Edit user](#)

Edit user

username *

Original password: *

New password: *

Confirm password: *

User groups *

User group list

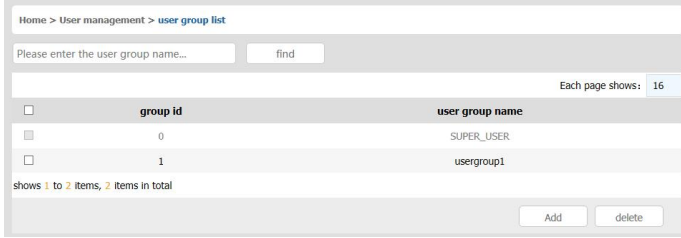

User group list interface: list all registered users, you can see more by page turning

- User group name search
Input user group name, it shows related user groups which make it convenient when you have a large number of users
- Add user group
Click **add** button, the window below appears

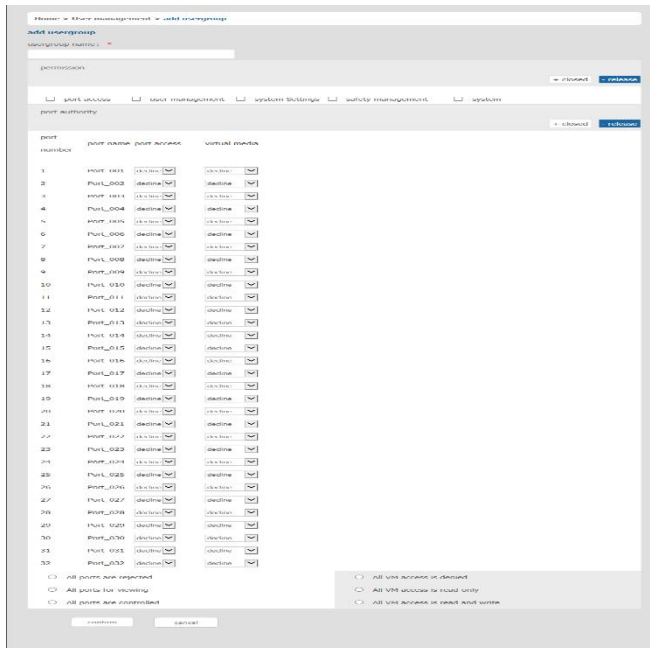

- 1) User group name: it only contains low case letter, number and “_”
- 2) Authority: mainly refers to management authority and operation authority, click show

more, authority menu appears (shown in picture above), click show less, authority menu disappears

- ✧ Port Access: Authority to access KVM, and control target server
- ✧ User Management: user management authority
- ✧ Device Setting: KVM device management authority
- ✧ Security Management: security management authority
- ✧ System Maintenance: system maintenance authority

3) Port authority: Set up access and operating authority for each port

■ Delete user group

Select the user group you want to delete, click **delete**

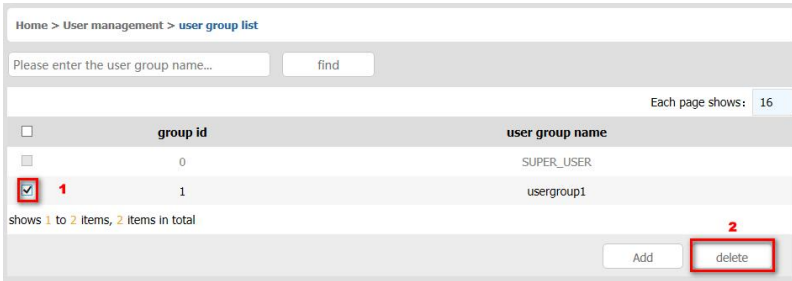

Note: SUPER_USER is system allocated which cannot be deleted

■ Edit user group

Click **1** edit user group window pop up ; For specific operation, please check “add user group”

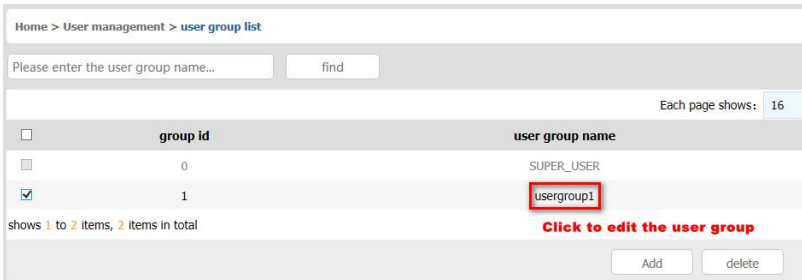

Change Password

The passwords which is using for logged user

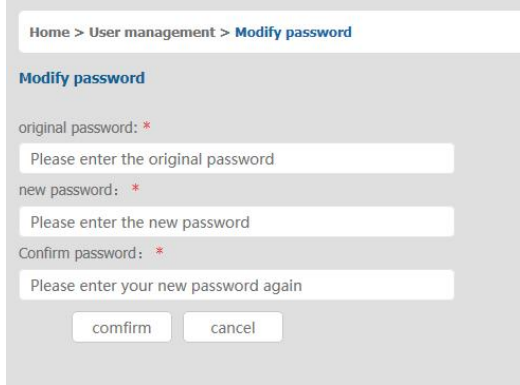

- 1) Old passwords: The passwords you are using
- 2) New passwords: Without strong password protection, the password can only compose of 1-16 letters, numbers or special characters (-@. \$! _); with strong password protection, the password should be filled in according to the rules of strong password protection. More details please check “security management—>security setting—>strong password”

6.2 System

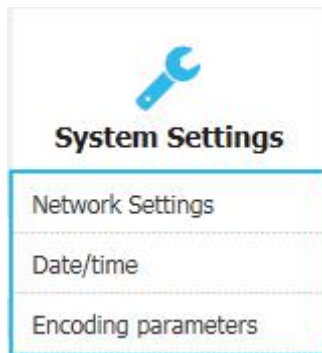

Network Setting

Home > System Settings > Network Settings

Network Settings

Nic set

IPv4 address:
192.168.0.168

Subnet mask:
255.255.255.0

default gateway:
192.168.1.1

mac address:
00:4a:b6:68:9a:31

DCSG Ip:
192.168.1.100

DCSG Port :
5500

confirm cancel

IP v 4 address setting:

- ✧ IP address: preset IP address
- ✧ Subnet mask: Generally, it should be consistent with other devices in the network.
- ✧ Default gateway: Generally, it should be consistent with other devices in the network.
- ✧ MAC address: physical address
- ✧ DCSG IP: the IP address should be the same with the Authentication Server IP address
- ✧ DCSG Port: The Port should be the same with the Authentication Server Port.

Date /Time setting

Home > System Settings > Date setting

Date setting

User setting time

Set date:
2019-03-08

Setting time:
10:20

Synchronize with the NTP server

Time server:

Time Zone Settings

Select time zone:
East 8 (Beijing, China) ▼

Confirm Cancel

System time setting:

- Customized time: manual setting
- Synchronize with the NTP server: the system automatically updates the time according to the time server
- Time zone setting: choose time zone

Encoding Parameters

Home > System Settings > Encoding parameters

Encoding parameters

Encoding parameters

Video formats: PAL

Stream type: Main stream

Frame rate: 25

IP ratio: 25

Rate limit: 6MBPS ▼

confirm cancel

6.3 Safety management



Security Settings

 A screenshot of the 'Security Settings' configuration page. The breadcrumb trail at the top reads 'Home > safety management > Security Settings'. The page is divided into several sections:

- login restrictions:** Includes 'Restrict single sign-on.' (checkbox), 'Enable password expiration' (checkbox) with a value of 50 (1~365day), and 'Cancellation free user' (checkbox) with a value of 36 (1 ~ 60 minutes).
- Strong password:** Includes 'Enable password strength rules' (checkbox), 'At least one lowercase letter.' (checkbox), 'At least one capital letter.' (checkbox), 'At least one numeric character.' (checkbox), 'At least one special character.' (checkbox), 'User password history depth.' (value 3), and 'Minimum/maximum password length.' (value 1).
- Login lock:** Includes 'Disable lock.' (radio button, selected), 'Account lock' (radio button, Attempts 60), and 'Timed lock' (radio button, Attempts 60, Locking time 2 (1-1440 minutes)).
- Encryption scheme:** Includes 'Local information encryption mode.' (dropdown menu, No encryption), 'Encryption mode is applied to KVM and virtual media.' (checkbox), and 'Local device reset mode.' (dropdown menu, Enable Local Fact).

 At the bottom of the page are 'confirm' and 'cancel' buttons.

- **Login restriction: user name login restriction**
 - ✧ Single sign on restriction: if one user name is logged in, it can no longer log in with this user name, if it is selected, you can log in with the user name
 - ✧ Enable passwords expiration: current password use days ranges from 1-365 days, if it is selected, the default is 50 days
 - ✧ Free user logs off: If user do not have operations after logging in a set time, the user will be logged off automatically
- **Login lock**
 - ✧ Disable Lock: when it is selected, login lock will be canceled
 - ✧ Account lock: set trying number of times for login attempts failed
 - ✧ Timed lock: set the account lock time when account login failed attempts are over the setting number of times
- **Strong password**
 - ✧ Enable strong password: when it is selected, the original password will be forced to be changed
 - ✧ Password history depth: new password cannot be the same as the latest 3 default passwords, this number can be changed, it ranges from 1-10
 - ✧ Strong password length: From 1-bit to 16 bits.

■ Encryption mode

DES
AES128
AES256

- ◇ Local information encryption mode: three encryption schemes and one un-encryption scheme
- ◇ Encryption mode is applied to KVM and virtual media: applied when it is selected

Audit Log

Home> security management > auditlog

maintype: all subtypes: all date selection: 2019-03-09 00:00:00 to 2019-03-09 10:23:29

search

Each page shows: 16

number	date	maintype	subtype	description
1	2019-03-09 08:00:07	operations	system boot	The user 'admin' 'system boot' on the host IP is '127.0.0.1'
2	2019-03-09 08:00:11	view	get config.	The user 'admin' 'get config.' on the host IP is '192.168.0.168'
3	2019-03-09 08:00:11	view	get config.	The user 'admin' 'get config.' on the host IP is '192.168.0.168'
4	2019-03-09 08:00:11	view	get config.	The user 'admin' 'get config.' on the host IP is '192.168.0.168'
5	2019-03-09 08:00:12	view	get config.	The user 'admin' 'get config.' on the host IP is '192.168.0.168'
6	2019-03-09 08:00:12	view	get config.	The user 'admin' 'get config.' on the host IP is '192.168.0.168'

6.4 System Maintenance

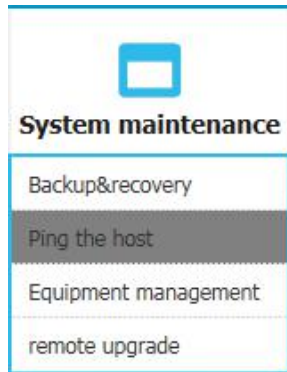

Provide system maintenance tools such as test tools, data backup and restart

Backup& Restore

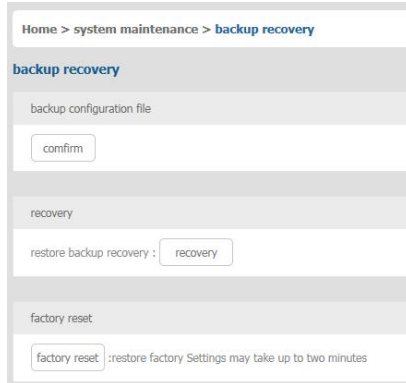

- **Backup** :backup current system settings
- **Restore**: restore the last backup of system
- **Factory reset**: Restore to factory state (KVM must be restarted to take effect)

Ping Host

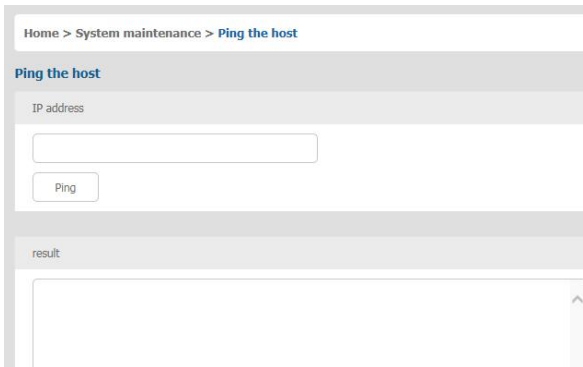

- **Test network connection state to target server**

Input IP address and click **ping** button , if network is smooth, result returns to “ip is active”; If not, it returns to “no response from IP” (IP is tested target server’s IP).

Equipment Management

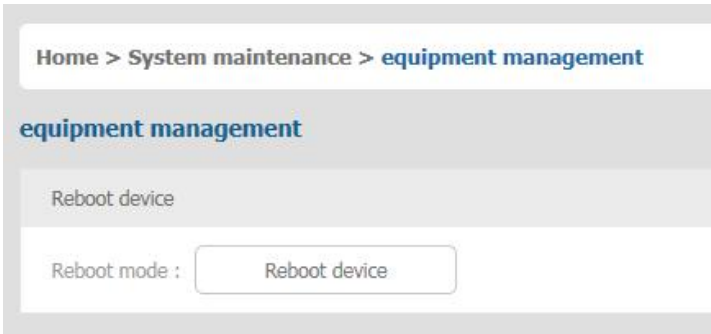

Remote upgrade

Provide users with better upgrade experience and continuous technical support

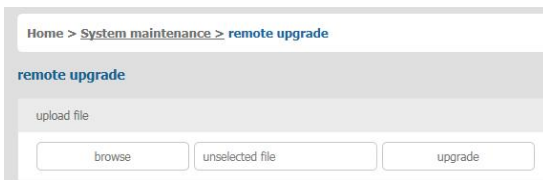

Upgrade method:

Click **【browse】** and select upgrade file, upload the file to the device, then click **【upgrade】** to finish upgrade

7. Appendix

7.1 Specifications (17.3")

Model		HT2708	HT2716	HT2724	HT2732
Computer Connections	Direct	8	16	24	32
	Max	8	16	24	32
Port Selection	Keyboard, Mouse	Button, UI, Web, Hotkey			
LCD Monitor	Model	FHD TFT			
	View Area	17.3"			
	Optimum Resolution	1920×1080@60Hz			
	Color	262K			
	Brightness	300cd/m ² (Typ)			
	Contrast Ratio	800:1 (Typ)			
	Pixel Pitch(mm)	0.1989(H) × 0.1989(W)			
Mouse	X/Y Resolution	>1000 points / inch, (40 points/mm)			
	Scroll Wheel	Supports Scroll Wheel function			
Keyboard		99 keys (82 keyboard + 17 number pad)			
Remote	Remote Control	KVM Control (ActiveX)			
	Management	Web			
	Security	DES Encrypted			
	Resolution	1920×1080@60Hz			
Power Input		100V- 240Vac, 50-60Hz, <1.5A			
Mounting distance		686-770mm (L=262mm) Mounting bracket can be customized for other mounting distance			
Power Consumption		23W	25W	27W	29W
Operating Temperature		0 — 50 °C			
Store Temperature		-20 —60 °C			
Humidity		0—80% RH, non-condensing			
Net Weight		11.7 kg	11.7kg	11.9kg	11.9kg
Product Dimension (W × D × H)		448mm×560mm×42.5mm			
Package Dimension (W × D × H)		765mm×615mm×185mm			

7.2 Specifications (18.5")

Model		HT2808	HT2816	HT2824	HT2832
Computer Connections	Direct	8	16	24	32
	Max	8	16	24	32
Port Selection	Keyboard, Mouse	Button, UI, Web, Hotkey			
LCD Monitor	Model	FHD TFT			
	View Area	18.47"			
	Optimum Resolution	1920×1080@60Hz			
	Color	16.7 M			
	Brightness	250cd/m ² (T y p)			
	Contrast Ratio	1000 : 1 (T y p)			
Mouse	Pixel Pitch(mm)	0.213(H) × 0.213(W)			
	X/Y Resolution	>1000 points / inch, (40 points/mm)			
	Scroll Wheel	Supports Scroll Wheel function			
Keyboard		99 keys (82 keyboard + 17 number pad)			
Remote	Remote Control	KVM Control (A9ctiveX)			
	Management	Web			
	Security	DES Encrypted			
	Resolution	1920×1080@60Hz			
Power Input		100V- 240Vac, 50-60Hz, <1.5A			
Mounting distance		686-770mm (L=262mm) Mounting bracket can be customized for other mounting distance			
Power Consumption		33W	35W	37W	39W
Operating Temperature		0 — 50 °C			
Store Temperature		-20 —60 °C			
Humidity		0—80% RH, non-condensing			
Net Weight		11.9 kg	11.9kg	12.1kg	12.1kg
Product Dimension (W × D × H)		448mm×560mm×42.5mm			
Package Dimension (W × D × H)		765mm×615mm×185mm			

7.3 Grounding Requirements

Make sure the KVM and the devices that connected to KVM are all connected to the ground.

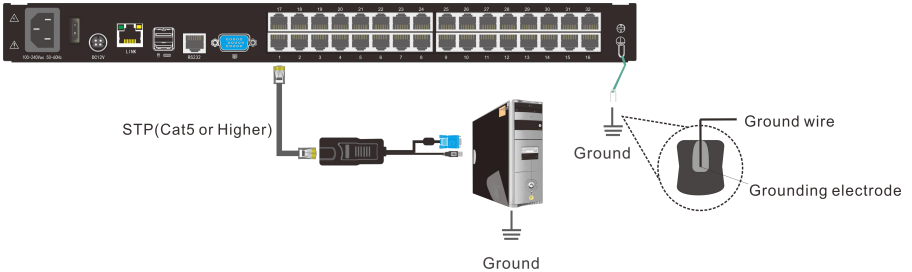

To improve the device safety, please make sure the device is connected to the ground and use the STP cable to connect the device.

The STP cable contains four shielded twisted pair and one ground wire, the ground wire should be welded into the RJ-45 connector.

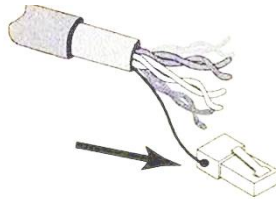

Grounding the STP shield cable (as shown below) , and make sure the metal RJ45 connector is tight shield.

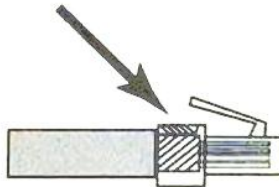

Connect one end of the RJ-45 connector to the ground RJ-45 connection socket.

