

# Rack Mount CAT5 KVM Switch (8 Port/16 Port/32 Port) User Manual



[www.kinankvm.com](http://www.kinankvm.com)

@all right reserved Shenzhen Kinan Technology Co., Ltd

Printing date: 2018/01

Version: V3.0

---

# CONTENTS

- Overview ..... 3**
  - Description ..... 3
  - Features ..... 3
- Hardware Installation..... 4**
  - Rack Mounting ..... 4
  - Cables (KVM switching module) ..... 6
  - Installation Instruction ..... 8
- Operation ..... 10**
- OSD Operation ..... 12**
  - OSD Functions ..... 13
    - F1-ADM* ..... 14
    - F2-Scan* ..... 17
    - F3-Set*..... 18
    - F4-Tool* ..... 20
    - F6-Edit port names*..... 21
    - F7-Set Quick View port* ..... 21
    - F8-LOUT*..... 21
  - Cascade Function ..... 22
- USB Keyboard Emulation ..... 24**
  - Mac keyboard..... 24
  - Sun keyboard ..... 25
- Appendix..... 26**
  - Specifications ..... 26
  - FAQ ..... 27

## Overview

### Description

CAT5 KVM switch can control multiple computers form a set of console (monitor, keyboard and mouse).

It is easy and fast to install the CAT5 KVM switch; you just need to connect corresponding cables to the right ports of the CAT5 KVM and its module without software configuration.

It's easy access to any selected computer via front panel LEDs or OSD menu, allowing convenient auto scan feature auto scanning and monitoring selected computers.

CAT5 KVM switch can connect multiple computers with RJ-45 connector and CAT5 connecting cables. Transmission distance is up to more than 150M, so it doesn't need a KVM extender.

### Features

- Access and control up to 4 / 8 /16 /32 computes
- Extending the transmitting distance between the console and the computer --1600x1200@60Hz(50m), 1280x1024@60Hz(100m),1024x768@60Hz(150m)
- Supports Multiple systems: PC, Mac, Sun etc.
- Two level password security--only authorized users view and control computers; up to four users and an administrator with a separate profile for each
- Users can set up different hot keys(【Scroll Lock】/【Caps Lock】/【F12】/【Ctrl】), auto scanning time, port display time, log out time, buzzer on/off and mouse on/off according to their different needs
- Convenient computer switching via mouse
- Broadcast mode--operations simultaneously performed on all selected computers
- No software--switching port via front panel LEDs and OSD menu
- Hot pluggable --add or remove computers without having to power down the switch
- Auto scan feature for monitoring user-selected computers
- Keyboard and mouse emulation function.

## Hardware Installation

### Rack Mounting

The Cat5 KVM switch will be installed in the front or rear rack cabinet. Make sure all the connecting computers as well as external device are shut down.

#### Installation instruction:

- 1) Remove the front or rear screw

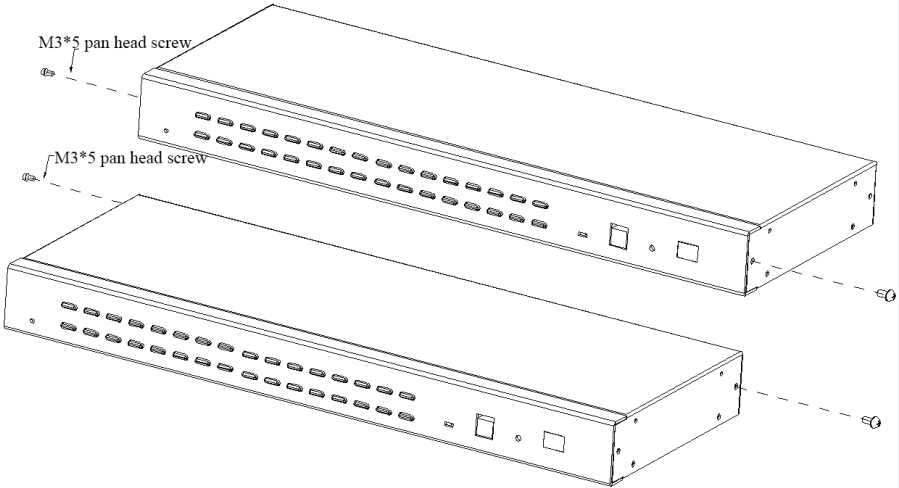

- 2) Screw the bracket to the front or rear part of the KVM switch

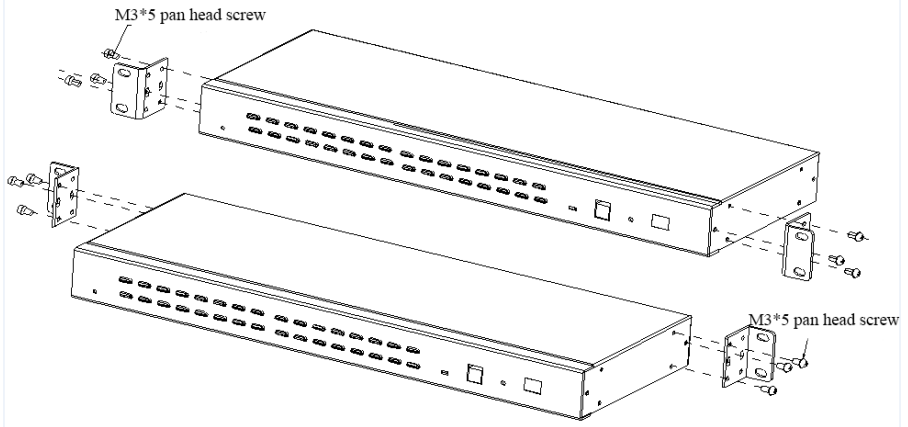

3) Screw the KVM device to the rack cabinet (front or rear part)

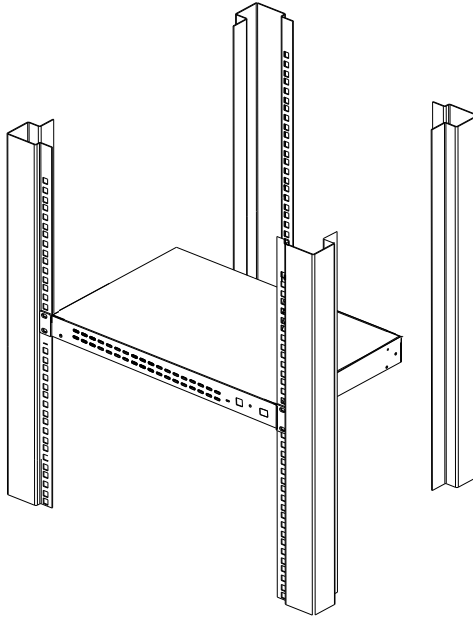

### Structure and Size

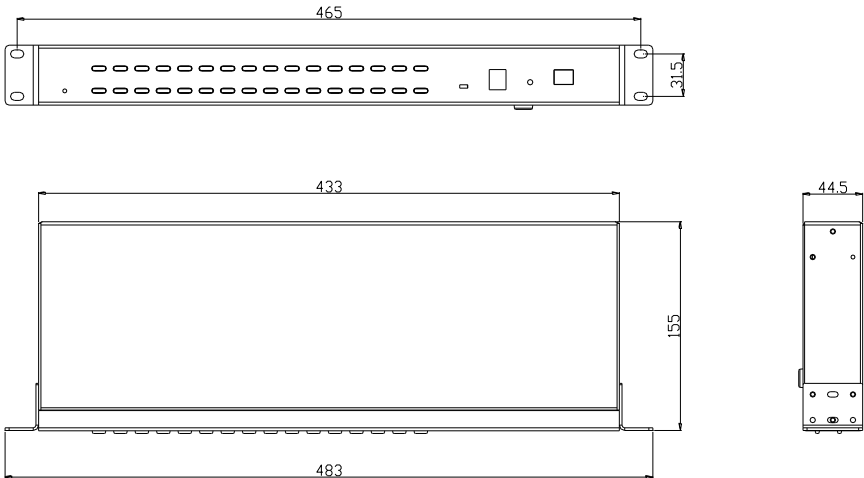

**Cables (KVM switching module)  
PS/2 CPU module**

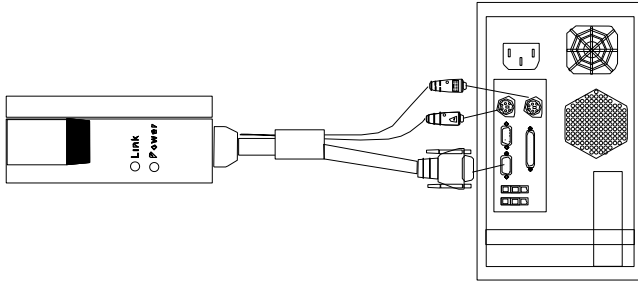

**USB CPU module**

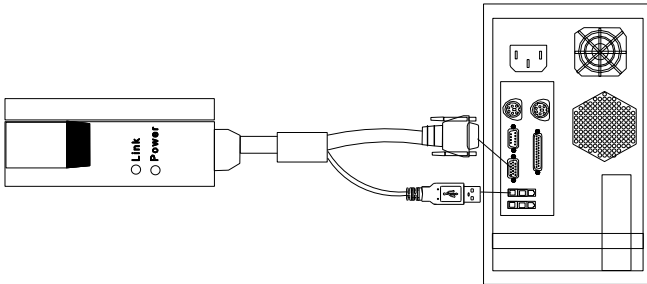

Table 1.3: Module LEDs

Components	Function	
Power LED	Flashing green light	The module is power on
	Green light keeps on	The module has been connected to the KVM
Link LED	Quickly flashing	The module is communicating with the host
	Orange light keeps on	The module has been selected by the KVM switch

Below KVM switching modules are needed:

Function	Module
PS/2 module	<b>CM-0906P</b>
USB module	<b>CM-0906U</b>

Rear View

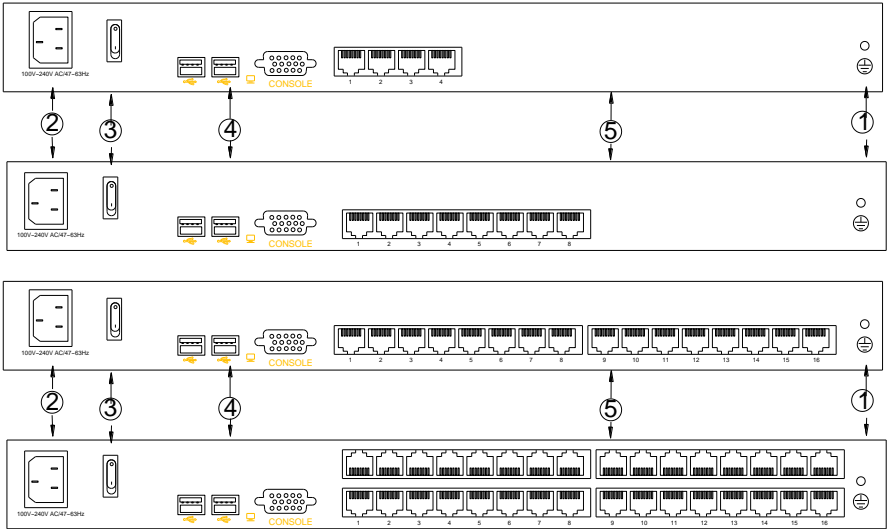

No.	Explanation
1	Ground connecting screws
2	Power Socket
3	Power Switch
4	Local Console
5	KVM Console

### Installation Instruction

Installation steps:

- 1) Make sure the IP KVM has been connected to the ground.
- 2) Connect KVM switching module to the host computer.
- 3) Connect KVM switching module to any available KVM port with CAT5 cable.
- 4) Plug the female part of the power cable into the KVM power socket and the male part into the 220V AC power socket.
- 5) Connect the local console (keyboard, monitor and mouse) to the console port.

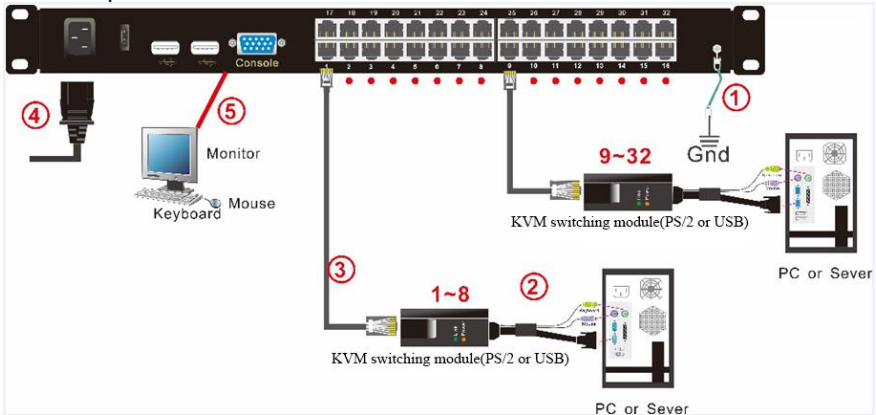
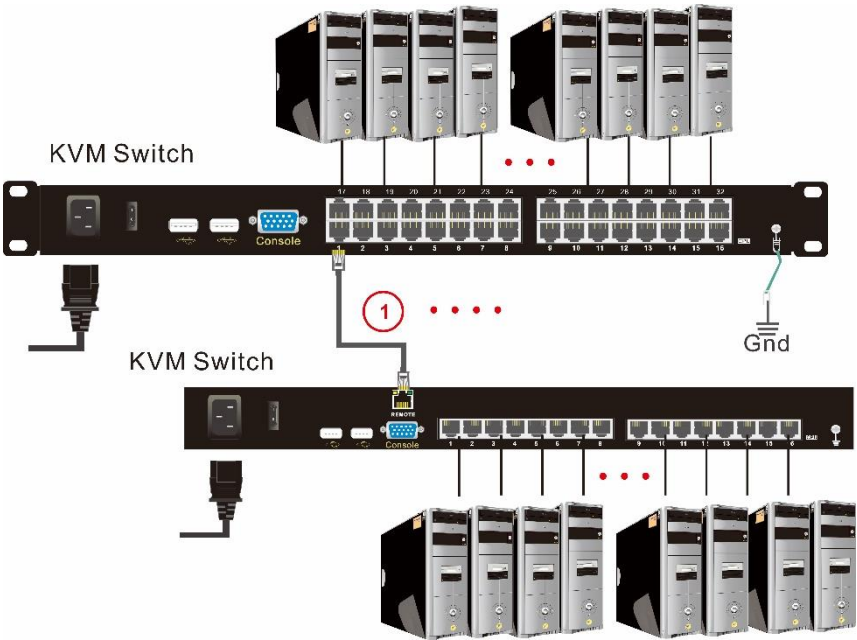

Diagram 2.4 Install KVM components



### Cascade Installation



#### Explanation:

1. Connect one port of the CAT5 cable to any RJ45 port of KC11/12, and connect the other port to the RJ45 port with "Chain in" of KC12 series.
2. Repeat above operation to cascade more KVM switches
  - 4 Port: max cascade 4 KVM switches
  - 8 Port: max cascade 8 KVM switches
  - 16 Port: max cascade 16 KVM switches
  - 32 Port: max cascade 32 KVM switches
3. Connect host computers according to 2-4.

### Operation

- 1) The KVM makes two “beep” sounds after power on; an OSD window appears for you to input user name and password.
- 2) Below password window appears:

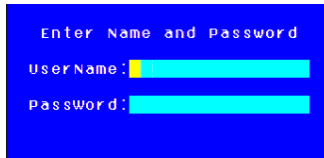

The default user name and pass word is blank, double click **【Enter】** to login and the OSD menu pops up, it’s ready to use the KVM switch.

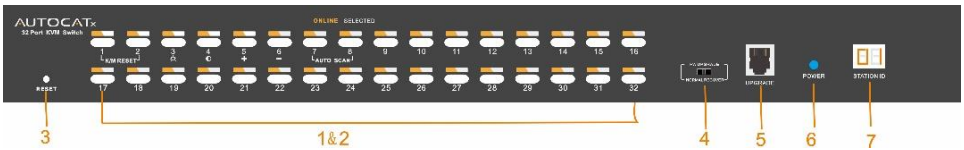
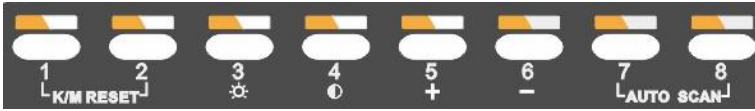

Diagram 1.3 KVM front views

Table 1.2

No.	Components	Function
1	Port selecting switch	Press LED buttons to select computer and the LED tube showing the selected port number
2	Port Selection Buttons& LEDs	Indicator LEDs are built into the switches, the online LED light is on the left and the selected LED light is on the right. 1) An online LED light(orange) indicates that the KVM has connected to its corresponding computer and power on. 2) A selected LED light(green) indicates that the computer attached to its corresponding port is up and running.
3	Reset KVM	Reset KVM switch
4	Upgrading switch	Pull this switch to upgrade inner IC
5	Software upgrading	This upgrading can only be done by the supplier, it is not support customer upgrading
6	Power LED	It shows the KVM has been power on and ready
7	Station ID	It shows the current port, when cascade to next bank, it will show the bank number

**Number key special function:**



- Press **【1】** and **【2】** at the same time for three seconds resets the keyboard and mouse.
- Press **【7】** and **【8】** at the same time for three seconds enters the auto scan mode.
- Press **【3】** for three seconds enters brightness adjusting mode.
  - 33 are flashing on the LED tube.
  - Then press **【5】**, **【6】** to adjust.
  - Press **【3】** exits or waits for five seconds and it will auto-exit.
- Press **【4】** for three seconds enters definition adjusting mode.
  - 44 are flashing on the LED tube.
  - Then press **【5】**, **【6】** to adjust.
  - Press **【4】** exits or waits for five seconds and it will auto-exit.
- Press **【5】** enters port selecting mode.
  - 55 are flashing on the LED tube.
  - Exits after select a cascading port or wait for five seconds and it will auto-exit.
- Press **【6】** for three seconds will initialize the brightness and definition of each port.

### OSD Operation

Double click the right button of the mouse or double click hotkey **【Scroll Lock】** to invoke below OSD main menu. You can customize the OSD hotkeys; find more details in OSD function instructions.

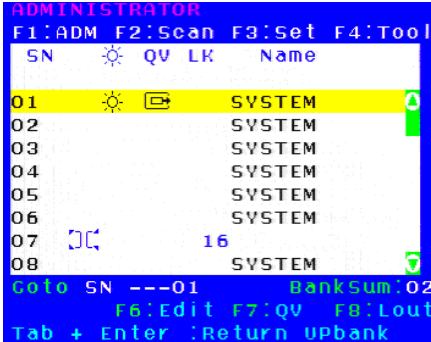

Heading	Explanation
SN	Port numbers
📺📺	Chain in KVM
▶	On line
☀	System on
📺	Quick view
🔊	BRC Port
📺	Channel is only be seen
Name	Port name

To access the OSD menu through keyboard:

1. In the submenus that appears, moving the highlight bar to your selected port and then press Enter.
2. Press **【Page Up】** or **【Page Down】** quickly moves to next BANK
3. Press any key from **【0-9】** to enter any port of current station

To access the OSD menu through mouse:

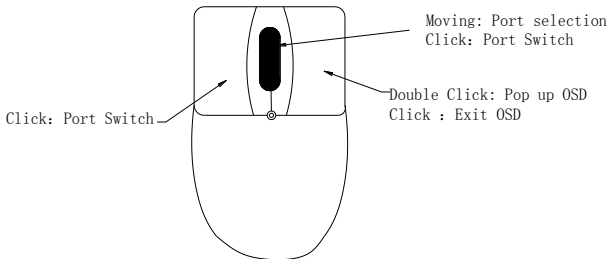

1. Select port via scroll wheel: switching to previous(↑)port, switching to next(↓) port.
2. Click left or middle button to confirm the port selection and close OSD menu at the same time.
3. Click right button exits the OSD main menu.

\*Note: Operate via keyboard after invoke the OSD menu via the touchpad.

**OSD Functions**

Menu	Keys	Submenu/Explanation
ADM	F1	Set User login-Set User login account and password Set accessible-Set access permissions BRC Mode -monitor multiple computers at the same time Load Default-reset the menu to the original factory default settings
Scan	F2	All-Lists all the ports on the installation Power On-lists only powered on ports that have attached computers. Quick View-Lists only the ports that have been selected as Quick View ports
Set	F3	Auto Scan-set scanning time period Port ID-set how long a port displays on the monitor OSD Hotkey-set OSD hotkeys Lout Time off- to set the time out value
Tool	F4	Reset RGB-Press Enter reset RGB Beeper <b>【On】</b> -press Enter switch Bee sounds Mouse Hot <b>【On】</b> -press Enter to close touchpad operating on OSD. Restore Values-press Enter restore the current user default value. About KVM- press Enter shows the KVM version
Edit	F6	Edits port names
QV	F7	Start or close Quick View
Lout	F8	Log out/lock the KVM
Exit	Esc	Press this key exits OSD menu
	Scroll Lock	Press this key exits OSD menu
	Num Lock	Press this key exits OSD menu

Table 1.5

The display screen will be distorted if the CAT5 cable is too long, for this case, you can adjust according to below steps:

1. Press **【+】** and ADJ FOCUS will pop up, then press **【+】**, **【-】** to adjust definition.
2. Press **【.】** and ADJ BRIGHT will pop up, then press **【.】**, **【.】** to adjust brightness.

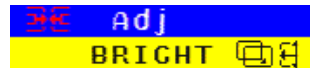

F1-ADM

● Menu Overview

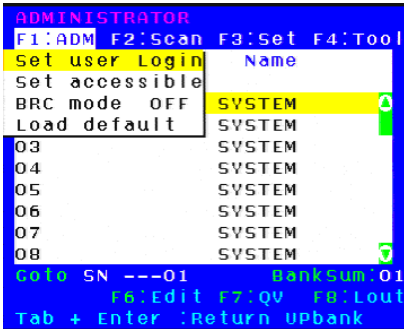

Operating instructions

- 1) Press **[F1]** or **[←][→]** enters the F1 submenus.
- 2) Press **[↑][↓]** moves the highlight bar to select the submenu.
- 3) Press **[Enter]** selects and exits ADM menu.
- 4) Press **[Esc]** cancels the operation and exits ADM menu.

● Menu Explanation

1. Set User Login—Press **[Enter]** selects Set User Login and a screen as below diagram 4-1.1 appears:

One administrator and four users account can be set (the account and the password are no more than 16 characters)

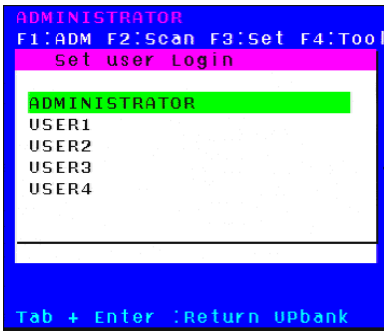

Enter →

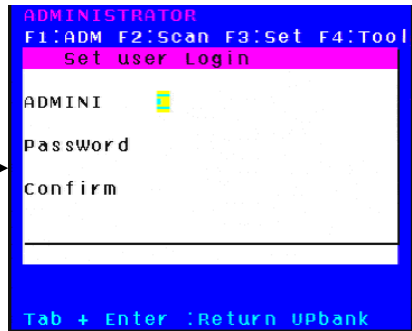

Diagram 4-1.1

Diagram 4-1.2

Note: You can set up an account and password according to diagram 4-1.2, then “ User setup ok” pops up showing that you have done your set,” and if “Password Not Match” pops up, you need to type in your password again as you did in your first type.

2. Set Accessible—press **【Enter】** to select Set Accessible, then below menu appears: (diagram 4-1.3)

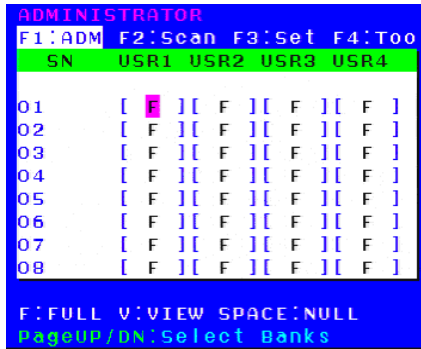

Diagram 4-1.3

Menu	Explanation
FULL	Full access function to the station and can do any operation to the ports
VIEW	Read only function, you can only read the port but you can't operate it if set this function.
NULL	If you set this function, the port will be not displayed on the user's OSD menu

Note: The administrator always has full access to all the ports.

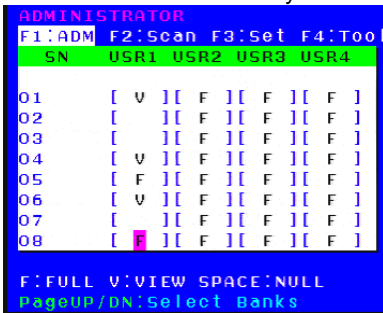

Diagram 4-1.4

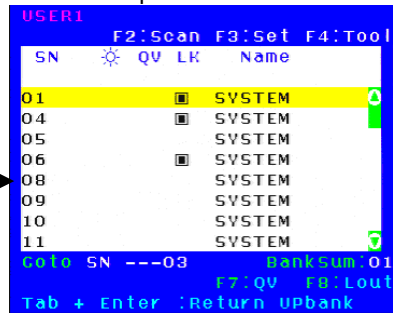

Diagram 4-1.5

- E.g.: 1) If you want to set access permission of [User1], press **【Space】** to select the permission options you need to set.
- 2) If you want to set access permission of cascade port, press **【Page Down】** moves to next level, and the SN changes into Bank – Port( e.g.: 02-01), then press **【Space】** to select the permission options you need to set.
- 3) [User1] log in OSD menu, below diagram 4-1.5.

3. BRC Mode Off - Press [Enter] to enter the BRC mode, enter the main menu, press 【F7】 to add or delete a port that need broadcast function. When BRC mode is effect, a speaker symbol appears in QV column. (See below diagrams). While BRC mode is in effect, we can synchronous operate multiple computer ports.

Note: While BRC mode is in effect, the mouse is forbidden to use.

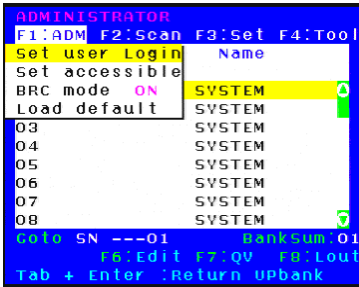

Diagram 4-1.6

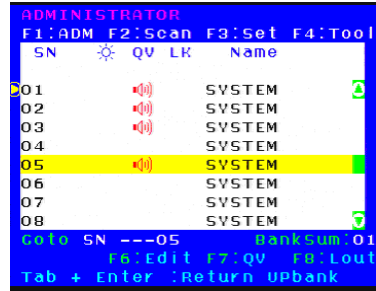

Diagram 4-1.7

- 1) Open BRC mode  
【F1】 ->BRC Mode OFF-> [Enter] -->BRC Mode ON (diagram 4-1.6)
- 2) Open the port that need broadcast function  
Press 【↑】【↓】 key—>select the port that need broadcast function → 【F7】 →a speaker symbol appears in the QV column which shows the port has entered broadcast mode.
- 3) Close the broadcasting port  
press【↑】【↓】key—>select the port→ 【F7】→exit BRC mode and the speaker symbol disappears
- 4) Exit BRC mode  
Invoke OSD main menu → 【F1】 ->BRC Mode ON -> 【Enter】 --> BRC Mode OFF, KVM exit BRC mode (diagram 4-1.8)

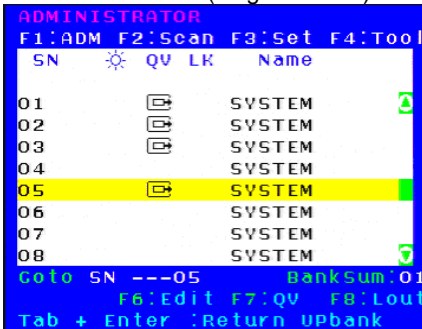

Diagram 4-1.8

【F1】 ->BRC Mode OFF -  
【Enter】,enter the main menu,  
all [Folder] symbols turn into  
speaker symbol(diagram  
4-1.8)

3.Load Default--- press 【Enter】 to select the submenu, all the set values are restoring to original factory default settings.



F2-Scan

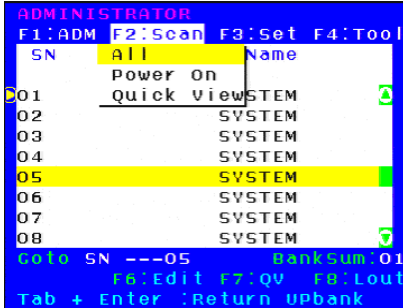

● Menu Overview



Operating instruction

- 1) Press **【F2】** or **【←】【→】** enters the F2: submenu.
- 2) Press **【↑】【↓】** moves the highlight bar to select the submenu.
- 3) Press **【Enter】** selects and exits Scan menu.
- 4) Press **【Esc】** cancels the operation and exits SCAN menu.

● Menu Explanation

Submenu	Explanation
All	Use this function to scan all ports according to the set scanning interval.
Power On	Use this function to scan all signal ports with  according to the set scanning interval.
Quick View	Use this function to scan all ports with  quick view symbols according to the set scanning interval.

F3-Set

● Menu Overview

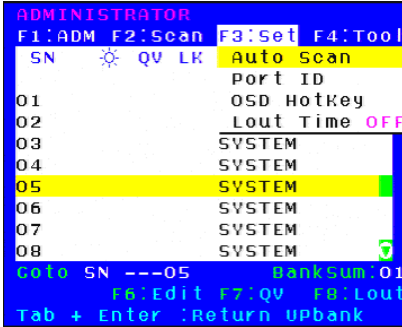

Operating instructions

- 1) Press **【F3】** or **【←】****【→】** enters the F3 submenus.
- 2) Press **【↑】****【↓】** moves the highlight bar to select the submenu.
- 3) Press **【Enter】** selects and exits Set menu.
- 4) Press **【Esc】** cancels the operation and exits Set menu.

● Menu Explanation

Submenu	Default value
Auto Scan	5S (effective range 5-99)
Port ID	0S: not display the port ID 1-98S: display the seconds, maximum 98s 99S: permanent display
OSD Hotkey	<b>【Scroll Lock】 + 【Scroll Lock】</b> <b>【Caps Lock】 + 【Caps Lock】</b> <b>【F12】 + 【F12】</b> <b>【Ctrl】 + 【Ctrl】 + 【KVM Hotkey】</b>
Lout Time off	0: off 01-99M:set the screen saver timeout, it is automatically log out if the current operator is no longer operate for a while, then the KVM will be locked and you need to enter user name and password to operate again

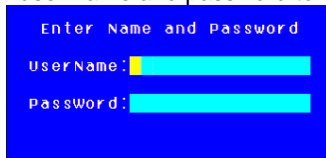

**Operating instruction**

1. Press **[F3]** and move the highlight bar with **[↓]** to select “OSD Hotkey” submenu.  
Press **[Enter]** and below screen appears:
2. KVM default hotkey: **[Scroll Lock]**

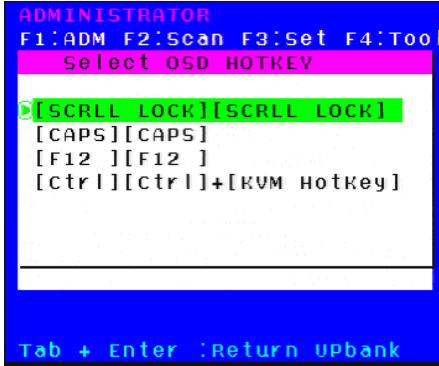

2. Select the “**[Ctrl] [Ctrl] + [KVM Hotkey]**” and press **[Enter]**, and then the **[Ctrl]** hotkey is available in this hotkey mode, the mouse hotkey can't enter the OSD menu

Invoke hotkey: double click **[L\_Ctrl]** + the corresponding function key

Function	Operating	Function description
Switching port	+2 number keys	Eg.: switch to port 4 by hotkeys <b>[L_Ctrl] + [L_Ctrl] + [0] + [4]</b>
	+ F1~ F8	Skip ports from 1-8
Invoke OSD main menu	+ “space”	This allows you to invoke OSD main menu (see OSD menu operation)

F4-Tool

● Menu Overview

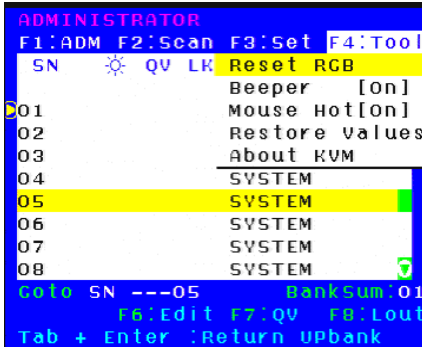

Operating instructions

- 1) Press【F4】or 【←】【→】enters the F4 submenus.
- 2) Press 【↑】【↓】 moves the highlight bar to select the submenu.
- 3) Press 【Enter】 selects and exits Tool menu.
- 4) Press 【Esc】 cancels the operation and exits Tool menu.

● Menu Explanation

Submenu	Instruction
Reset RGB	Restore the video signal to the default value.
Beeper 【On】	The beeper can be turned on or off with this function.
Mouse Hot 【On】	To open and close the mouse with this function. We can't operate the OSD when it is 【Off】 .
Restore Values	Restore to original factory default values.
About KVM	It shows the KVM version information.

F6-Edit port names

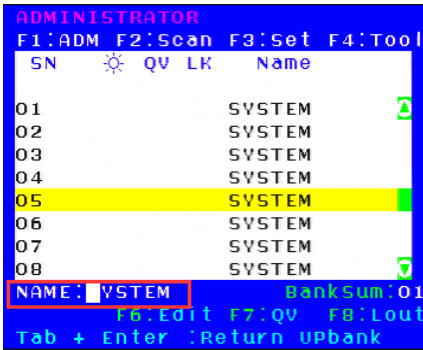

- Select the port with **【↑】【↓】** key;
- Press F6 and key in the new name or modify the old one, then press Enter to save the name and exit editing.
- Press **【Esc】** to cancel and exit the editing.

Note:

The NAME characters include:

All alpha characters: A-Z

All numeric characters: 0-9

Default value: SYSTEM

F7-Set Quick View port

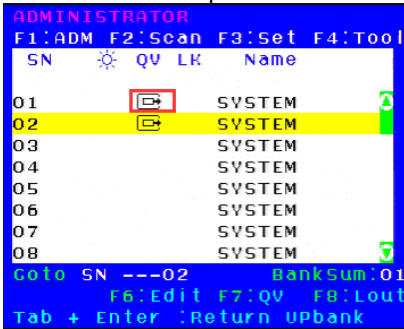

- Select ports with **【↑】【↓】** keys;
- Press F7 to include current port as Quick View, then an arrowhead appears in the QV column to indicate so;

Note:

Press F7 to cancel the QV symbol if the current port has already have a QV arrowhead symbol in its QV column; if you want to cancel all the QV function, press Restore Values under F4:Tool.( The port name restores to default setting at the same time.)

F8-LOUT

- Press **【F8】** exits the OSD main menu and fully exits current port, then the log in window appears:

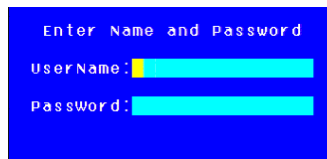

- Users must log in all over again to regain access to the OSD.

Cascade Function

1. Operate the host computer under cascade

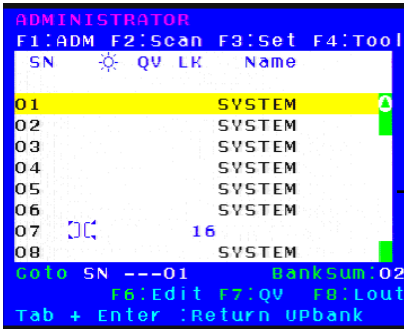

Diagram 4-1.5

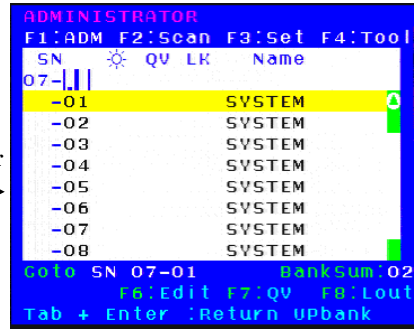

Diagram 4-1.6

Explanation:



Shows that we have already connected an 8 port KVM to port 2(see diagram 4-1.5), we can connect 8 computers to the 8 port KVM. Press **【 Pa UP 】** to select port on current station, then press **【 Enter 】** to operate the port.

2. Return to OSD main menu

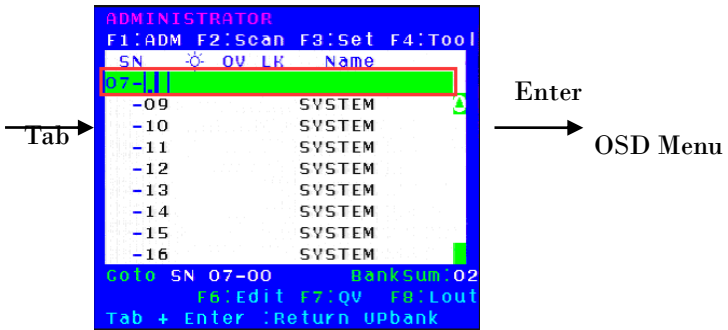

Note:

1. Press **【 Tab 】** , then **02 -**  in column SN changes into green, which indicates the port has been selected. Then press **【 Enter 】** to return to main menu to operate other ports.
2. Press **【 Pa DN 】** returns to the OSD main menu.

**OSD Factory Default Settings**

<b>Settings</b>	<b>Default values</b>
OSD hotkey	【 Scroll Lock 】【 Scroll Lock 】
Default ADM user name	【 Enter】
Default ADM password	【 Enter】
Port display duration	5 seconds
Port display mode	Port No. port name
Port name	SYSTEM
Scan duration	5 seconds
Scan mode	All
Auto log out	【 Esc】



**Operating system****Support operating system:**

<b>Operating system</b>		<b>Version</b>
Windows		2000 or higher
Linux	RedHat	6.0 or higher
	SuSE	8.2 or higher
	Mandriva(Mandrake)	9.0 or higher
UNIX	AIX	4.3 or higher
	FreeBSD	3.51 or higher
	Sun	Solais8 or higher
Nove11	Netware	5.0 or higher
Mac		8.6 or higher
DOS		6.2 or higher

## USB Keyboard Emulation

### Mac keyboard





The PC compatible (101/104 keys) keyboard can emulate the functions of the Mac keyboard. The emulation mappings are listed in the below table:

PC keyboard	MAC keyboard
[Shift]	Shift
[Ctrl]	Ctrl
	
L_Win & "1"	
L_Win & "2"	
L_Win & "3"	
L_Win & F12	
[Alt]	Alt
[Print Screen]	F13
[Scroll Lock]	F14
	=
[Enter]	Return
[Backspace]	Delete
[Insert]	Help



## Sun keyboard

The PC compatible (101/104 keys) keyboard can emulate the functions of the Sun keyboard when the control key [L\_Win] is used in conjunction with other keys. The corresponding functions are shown in the below table:

PC keyboard	Sun keyboard
L_Win&L_Alt	Stop
L_Win&F4	Again
L_Win&L_Ctrl	Props
L_Win&F5	Undo
L_Win&F1	Front
L_Win&F6	Copy
L_Win&F2	Open
L_Win&F7	Paste
L_Win&F3	Find
L_Win&F8	Cut
L_Win&"1"	V_DN 
L_Win&"2"	Mute 
L_Win&"3"	V_UP 
L_Win&F12	Power 
L_Win&F11	Help
L_Win&L_Shift	Compose
	◆

## Appendix Specifications

Model		KC2108	KC2116	KC2132	
Direct		8	16	32	
Max		256	512	1024	
Port Selection		Front panel pushbuttons, keyboard hotkeys, OSD (On-Screen Display)			
Connector	Console	Monitor Keyboard Mouse	1x HDB-15 Female(blue) 2x USB TYPE A		
	KVM port (RJ45)		8	16	32
	Upgrading switch		1x RJ11 Female		
	Power		3-Prong AC socket		
Switch	Port Selecting (buttons)		8	16	32
	Reset		1x tuch-button		
	Upgrading switch		1x pull switch		
	Power		1x rocker switch		
Indicating LEDs	Online (green)		8	16	32
	Selected(orange)		8	16	32
	Power		1(blue)		
	Cascading/port display		2x7- Segment (orange)		
I/R Value		100V- 240Vac , 50-60Hz , <1.5A			
Video Signal		2048x1536; DDC2B			
Power Consumption		4W	5W	6W	
Emulation	Keyboard/Mouse		PS/2, USB		
Environment Requirements	Working Temperature		0-40°C		
	Store Temperature		-20-60°C		
	Humidity		0-80%RH,Non-condensing		
Physical Features	Material		Metal		
	Weight		2.5kg	2.7kg	2.9kg
	Dimension		433 x 171 x 44.5mm		

## FAQ

1. There is no image after open up.

Solutions:

- 1) Check the power LED, if it is not keeps on, check the 220V power input.
- 2) Make sure the monitor is connected and power on.

2. No password window pops up after boot, there is no response from the keyboard

Solutions:

- 1) Make sure the keyboard is OK.
- 2) Plug out the PS/2 keyboard, then plug in and the keyboard indicating LED flash once.

3. Enter the password window and select one port, there is no host computer screen.

Solutions:

- 1) Check the current port, make sure it has connected to the host computer, make sure the host computer output video signal.
- 2) Check the LED of corresponding port (green and orange light keep on at the same time).
- 3) Check the network cable connection.
- 4) Check the module connection.
- 5) Change a normal module to that port, if OK then the module is damaged.

4. Poor display quality of PC screen.

Solutions:

- 1) Adjust the definition and brightness.
- 2) Use good quality network cable such as CAT5 cables or upper.
- 3) Shorten the network cable length.
- 4) Lower the display resolution.

5. I can't invoke the OSD main menu.

Solutions:

- 1) Check the keyboard LED, make sure it is flashing, if not, invoke the OSD menu again.
- 2) If the keyboard LED is flashing, it means we have entered the OSD menu, click **【Esc】**, **【Scroll\_Lock】** or **【Num\_Lock】** exits OSD menu and invoke again.

6. When I switch to one port, the keyboard and mouse do not work.

Solutions:

- 1) Make sure you have exited the OSD menu, we have entered the OSD menu if the keyboard LED is flashing, and we can't operate the host computer via keyboard and mouse at this moment.
- 2) Make sure we can operate the OSD menu via keyboard and mouse, is so the KVM is OK.
- 3) Moving the mouse or clicking keyboard to see whether the KVM switching module orange LED is flashing, if not, please change a module.
- 4) Reboot the host computer; make sure the KVM module has been connected to the host computer before boot.